

日本のひなた宮崎国スポ【ハンドボール】宮崎市 総合体育館【リハーサル大会】

競技	番号	施設名称	設置エリア							リハーサル大会
	A	テクニカルオフィシャル席								
No.	品名	仕様・規格	リース	製作	既存	引継	数量	単位	備考	
1	長机				○		2	台		
2	折畳椅子				○		6	脚		
3	長机囲い			○			1	式		
4										
5										
6										
7										
8										
9										
10										
11										
12										
13										
14										
15										
16										
17										
18										
19										
20										
21										
22										
23										
24										
25										
26										
27										

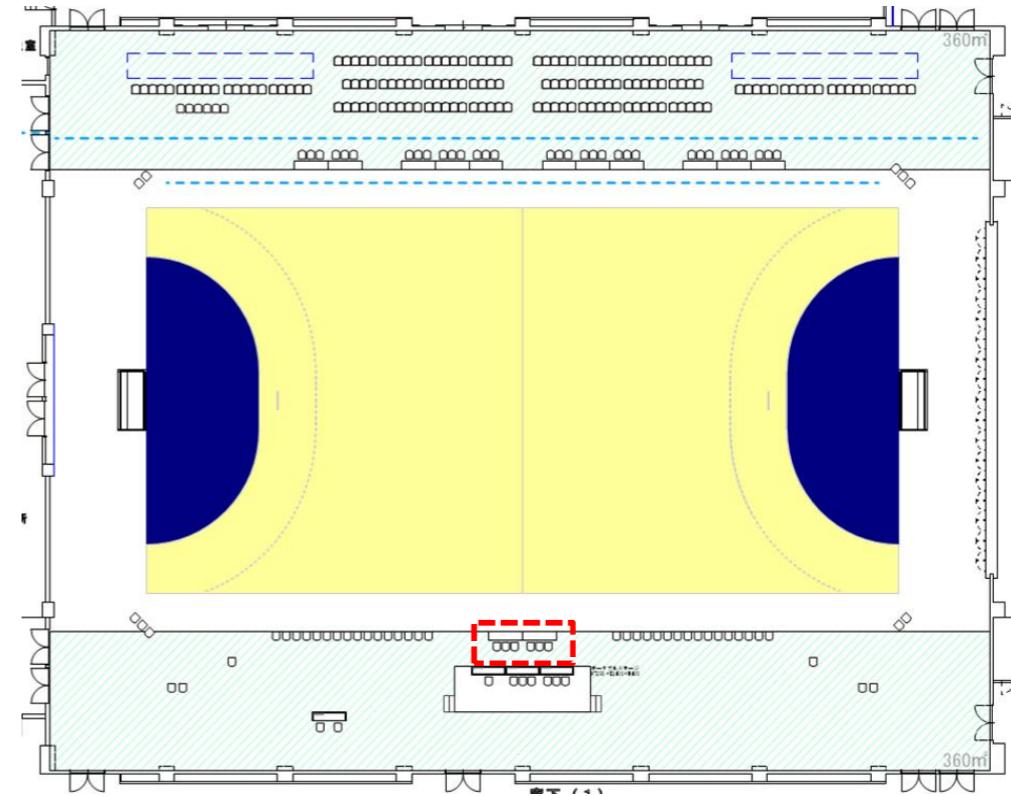

競技	番号	施設名称	設置エリア							リハーサル大会
	B	JHAオフィシャル席								
No.	品名	仕様・規格	リース	製作	既存	引継	数量	単位	備考	
1	長机				○		1	台		
2	折畳椅子				○		1	脚		
3	白布		○				1	枚		
4	ポータブルステージ		○				6	台		
5	ステップ		○				2	式		
6										
7										
8										
9										
10										
11										
12										
13										
14										
15										
16										
17										
18										
19										
20										
21										
22										
23										
24										
25										
26										
27										

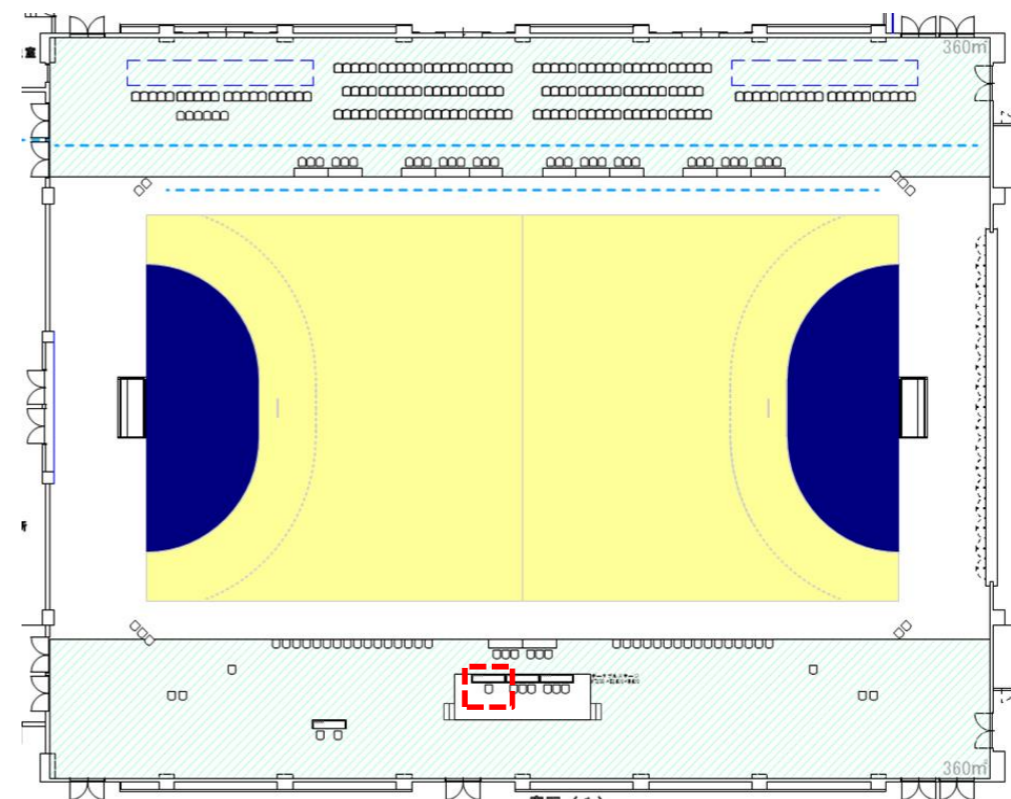

競技	番号	施設名称					設置エリア			
	C	公式記録席								
No.	品名	仕様・規格	リース	製作	既存	引継	数量	単位	備考	
1	長机				○		2	台		
2	折畳椅子				○		6	脚		
3	白布		○				2	枚		
4	ノートパソコン		○				1	台		
5	モバイルWi-Fiルーター		○				1	台		
6										
7										
8										
9										
10										
11										
12										
13										
14										
15										
16										
17										
18										
19										
20										
21										
22										
23										
24										
25										
26										
27										

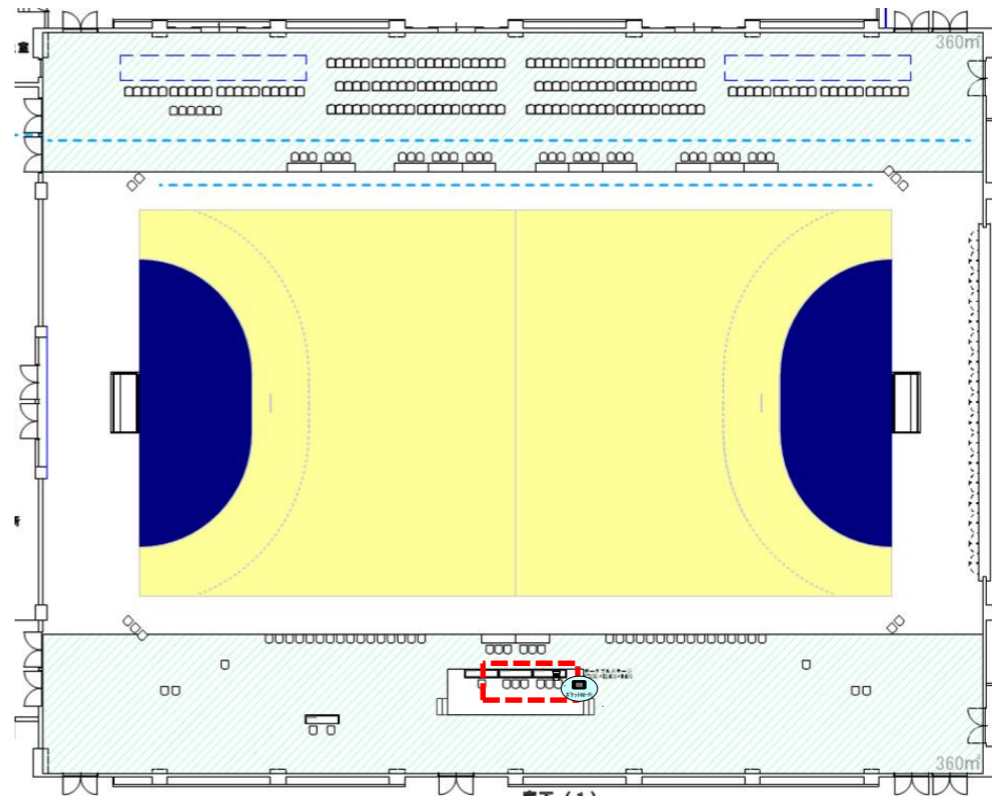

競技	番号	施設名称					設置エリア			
	D	放送席								
No.	品名	仕様・規格	リース	製作	既存	引継	数量	単位	備考	
1	リハは設置しない									
2										
3										
4										
5										
6										
7										
8										
9										
10										
11										
12										
13										
14										
15										
16										
17										
18										
19										
20										
21										
22										
23										
24										
25										
26										
27										

競技		番号	施設名称				設置エリア			
		E	競技役員席							
No.	品名	仕様・規格	リース	製作	既存	引継	数量	単位	備考	
1	長机				○		3	台		
2	折畳椅子				○		9	脚		
3	卓球フェンス				○		27	枚		
4										
5										
6										
7										
8										
9										
10										
11										
12										
13										
14										
15										
16										
17										
18										
19										
20										
21										
22										
23										
24										
25										
26										
27										

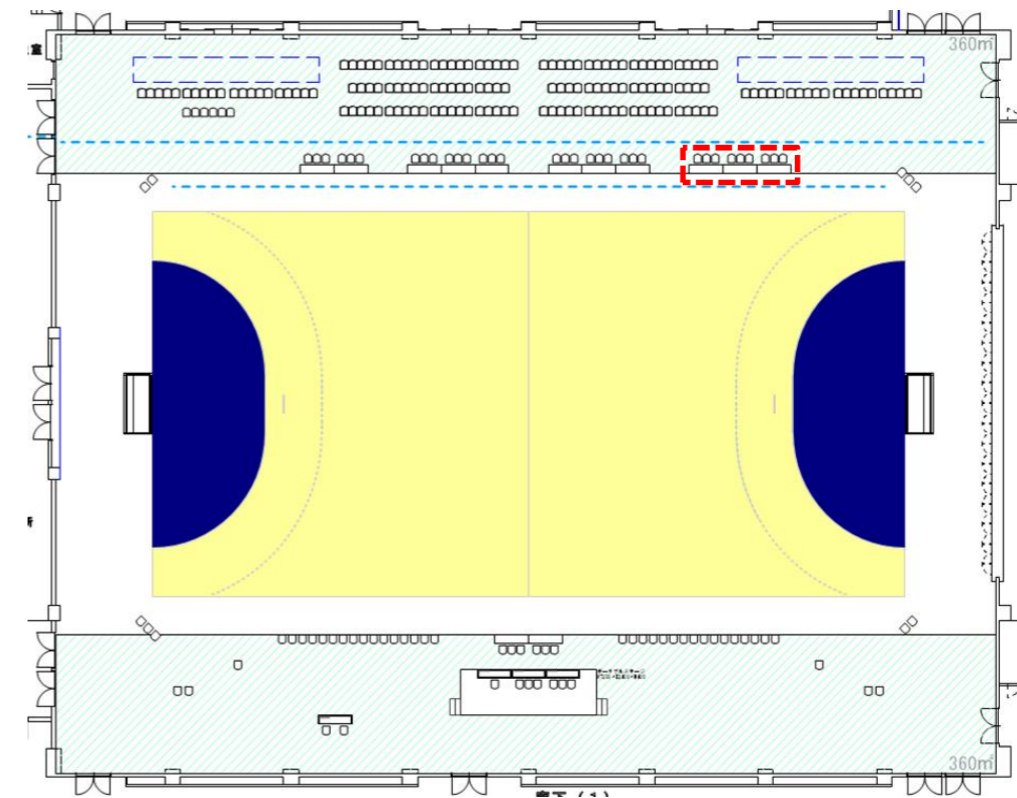

競技		番号	施設名称				設置エリア			
		F	審判員席							
No.	品名	仕様・規格	リース	製作	既存	引継	数量	単位	備考	
1	長机				○		3	台		
2	折畳椅子				○		9	脚		
3										
4										
5										
6										
7										
8										
9										
10										
11										
12										
13										
14										
15										
16										
17										
18										
19										
20										
21										
22										
23										
24										
25										
26										
27										

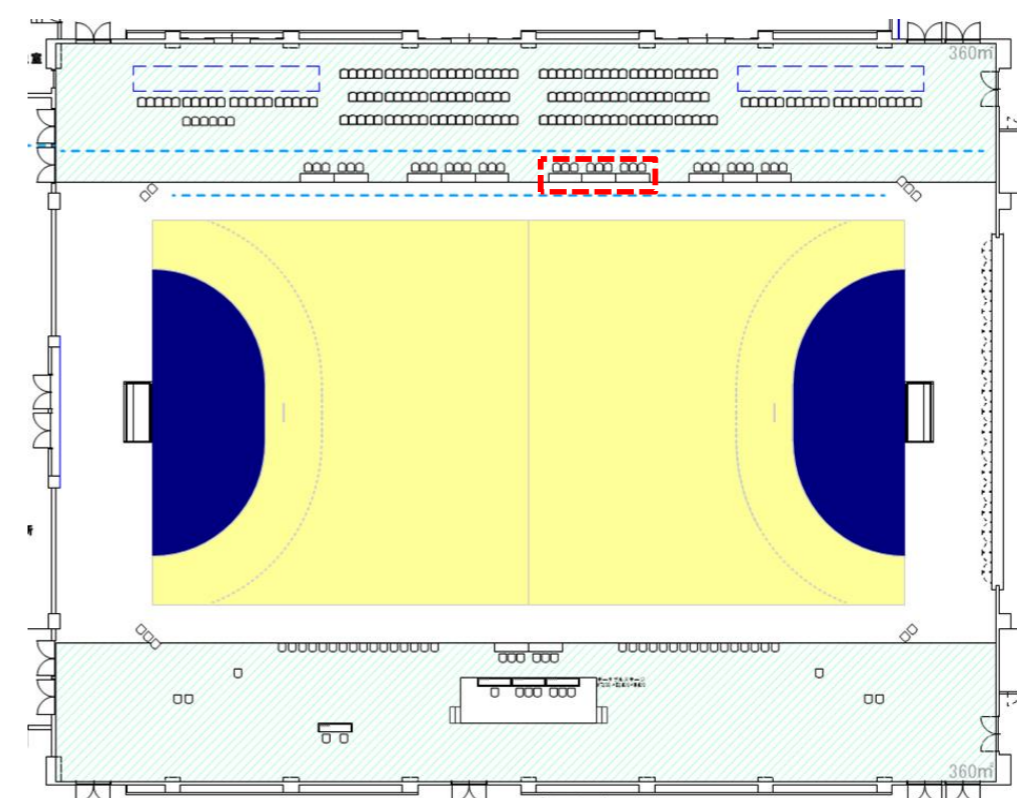

競技	番号	施設名称					設置エリア			
	G	来賓席								
No.	品名	仕様・規格	リース	製作	既存	引継	数量	単位	備考	
1	長机				○		3	台		
2	折畳椅子				○		9	脚		
3										
4										
5										
6										
7										
8										
9										
10										
11										
12										
13										
14										
15										
16										
17										
18										
19										
20										
21										
22										
23										
24										
25										
26										
27										

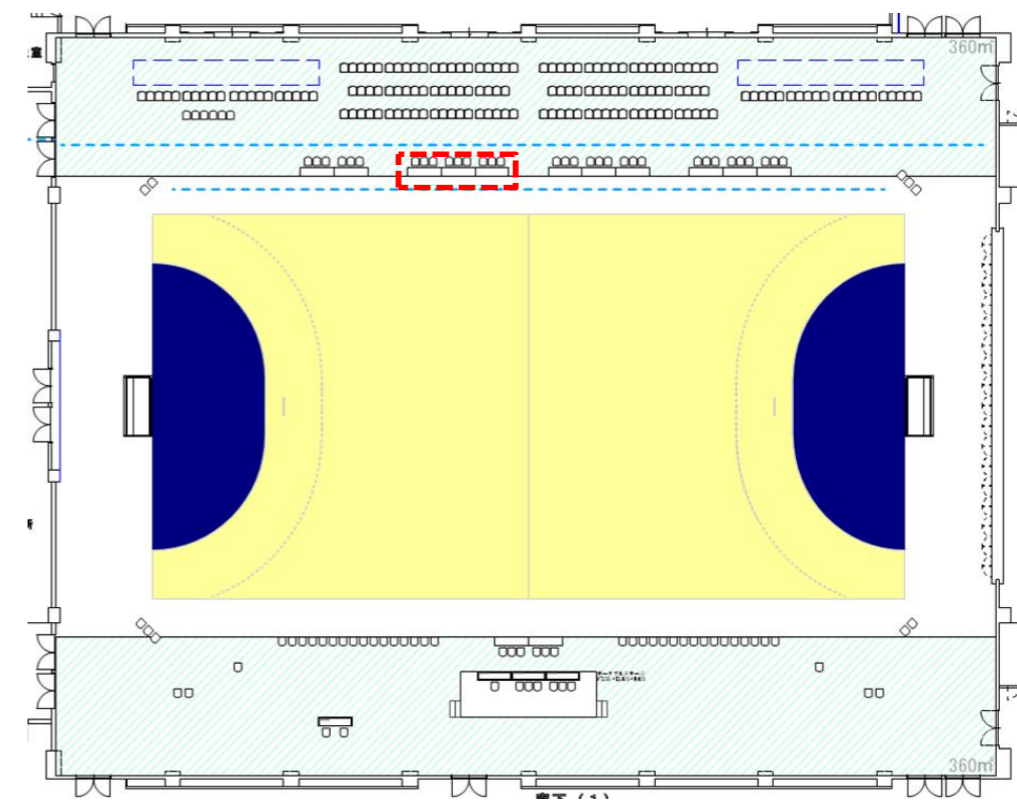

競技	番号	施設名称					設置エリア			
	H	救護席								
No.	品名	仕様・規格	リース	製作	既存	引継	数量	単位	備考	
1	長机				○		1	台		
2	折畳椅子				○		2	脚		
3	車椅子				○		1	台		
4	担架				○		1	台	救護室分使用	
5										
6										
7										
8										
9										
10										
11										
12										
13										
14										
15										
16										
17										
18										
19										
20										
21										
22										
23										
24										
25										
26										
27										

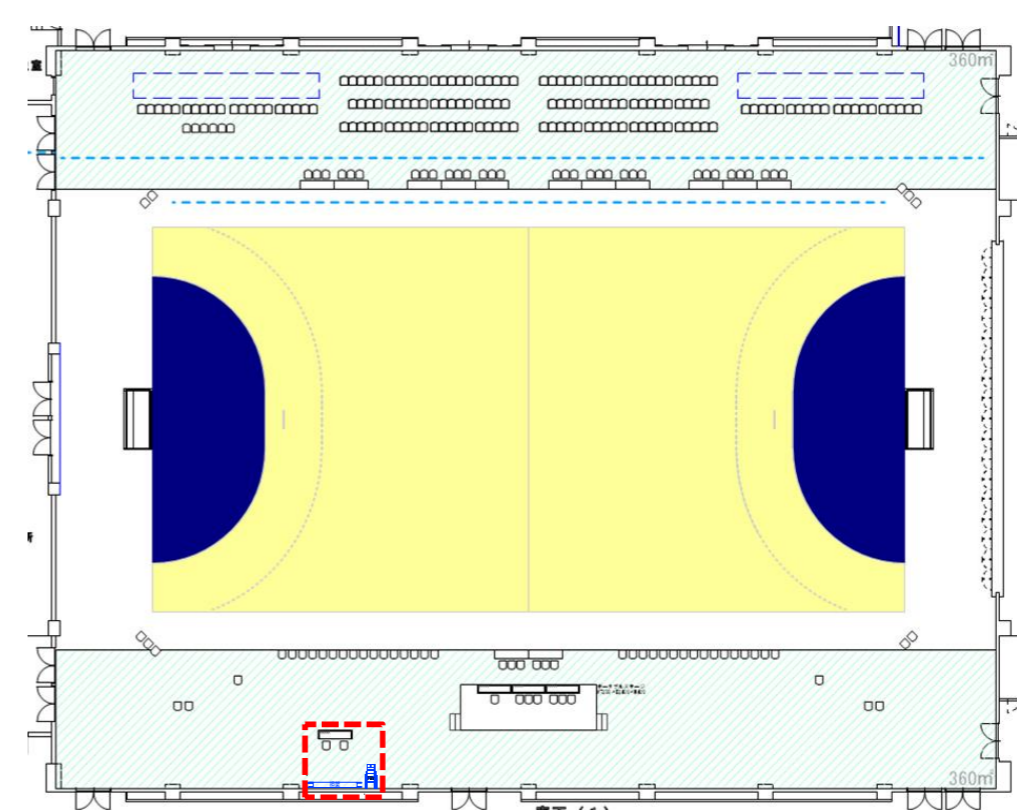

日本のひなた宮崎国スポ【ハンドボール】宮崎市 総合体育館【リハーサル大会】

競技	番号	施設名称					設置エリア		
	I	報道員・視察員席							
No.	品名	仕様・規格	リース	製作	既存	引継	数量	単位	備考
1	長机				○		2	台	
2	折畳椅子				○		6	脚	
3									
4									
5									
6									
7									
8									
9									
10									
11									
12									
13									
14									
15									
16									
17									
18									
19									
20									
21									
22									
23									
24									
25									
26									
27									

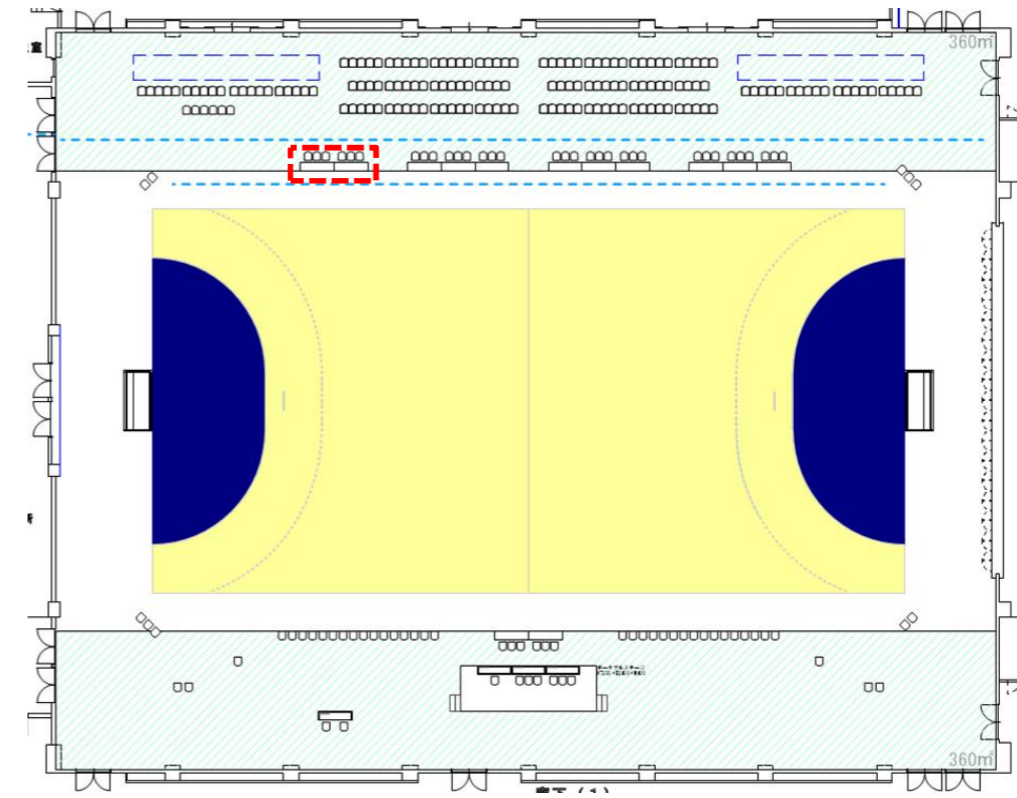

競技	番号	施設名称					設置エリア		
	J	選手席							
No.	品名	仕様・規格	リース	製作	既存	引継	数量	単位	備考
1	折畳椅子				○		32	脚	
2	プラカード台座		○				2	個	
3									
4									
5									
6									
7									
8									
9									
10									
11									
12									
13									
14									
15									
16									
17									
18									
19									
20									
21									
22									
23									
24									
25									
26									
27									

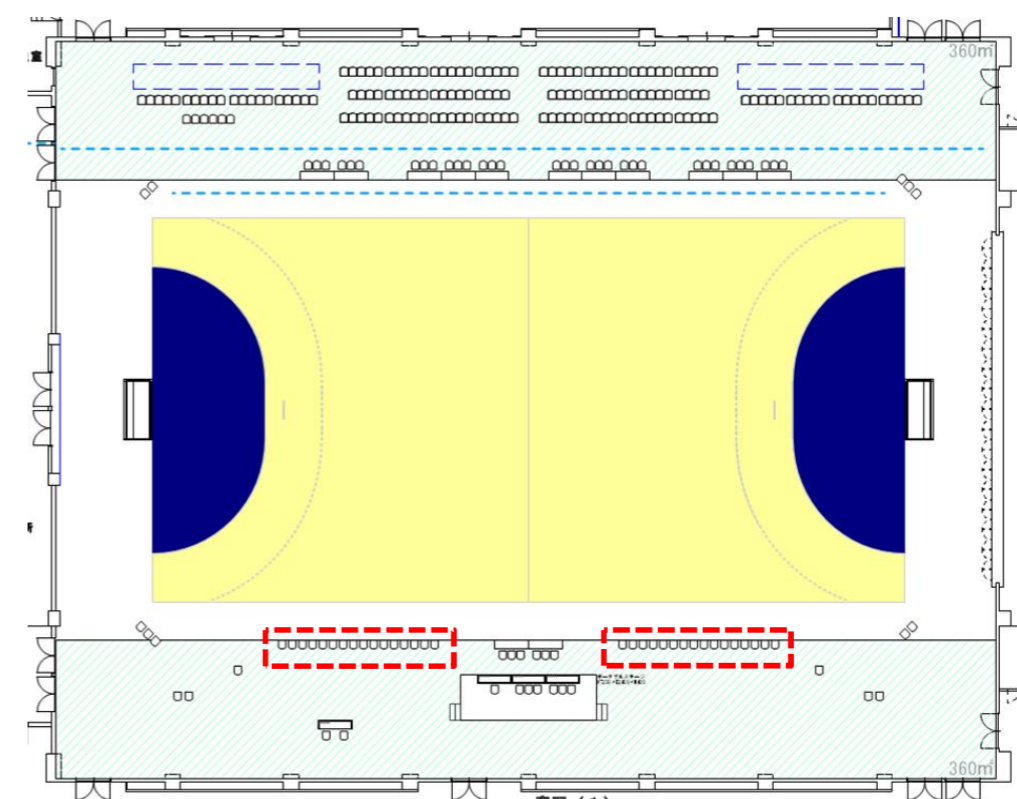

競技	番号	施設名称					設置エリア		
	K	トレーナー席							
No.	品名	仕様・規格	リース	製作	既存	引継	数量	単位	備考
1	折畳椅子				○		2	脚	
2									
3									
4									
5									
6									
7									
8									
9									
10									
11									
12									
13									
14									
15									
16									
17									
18									
19									
20									
21									
22									
23									
24									
25									
26									
27									

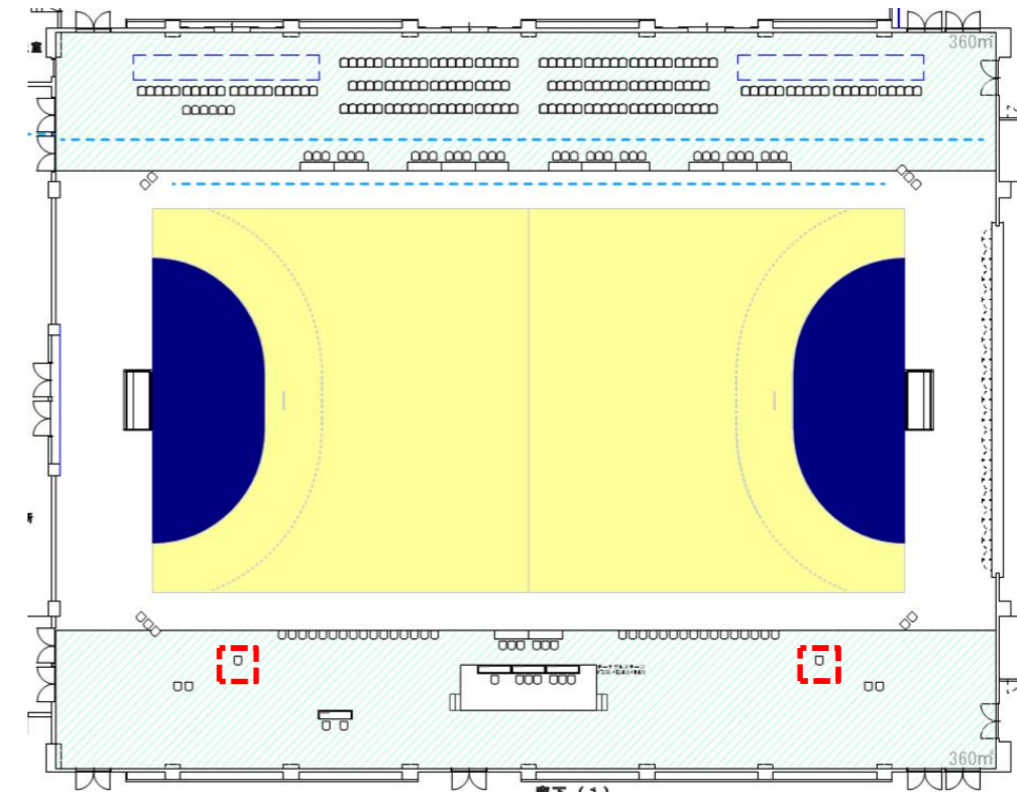

競技	番号	施設名称					設置エリア		
	L	コートキーパー席							
No.	品名	仕様・規格	リース	製作	既存	引継	数量	単位	備考
1	折畳椅子				○		10	脚	
2									
3									
4									
5									
6									
7									
8									
9									
10									
11									
12									
13									
14									
15									
16									
17									
18									
19									
20									
21									
22									
23									
24									
25									
26									
27									

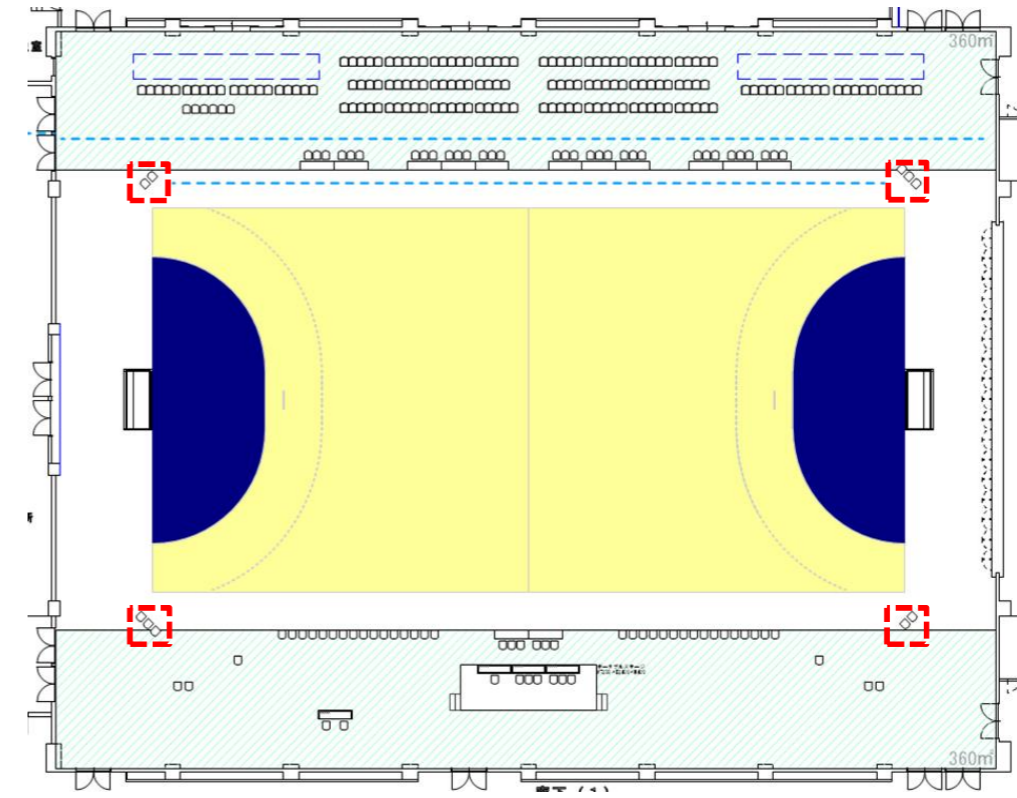

競技	番号	施設名称					設置エリア			
	M	失格者席								
No.	品名	仕様・規格	リース	製作	既存	引継	数量	単位	備考	
1	折畳椅子				○		4	脚		
2										
3										
4										
5										
6										
7										
8										
9										
10										
11										
12										
13										
14										
15										
16										
17										
18										
19										
20										
21										
22										
23										
24										
25										
26										
27										

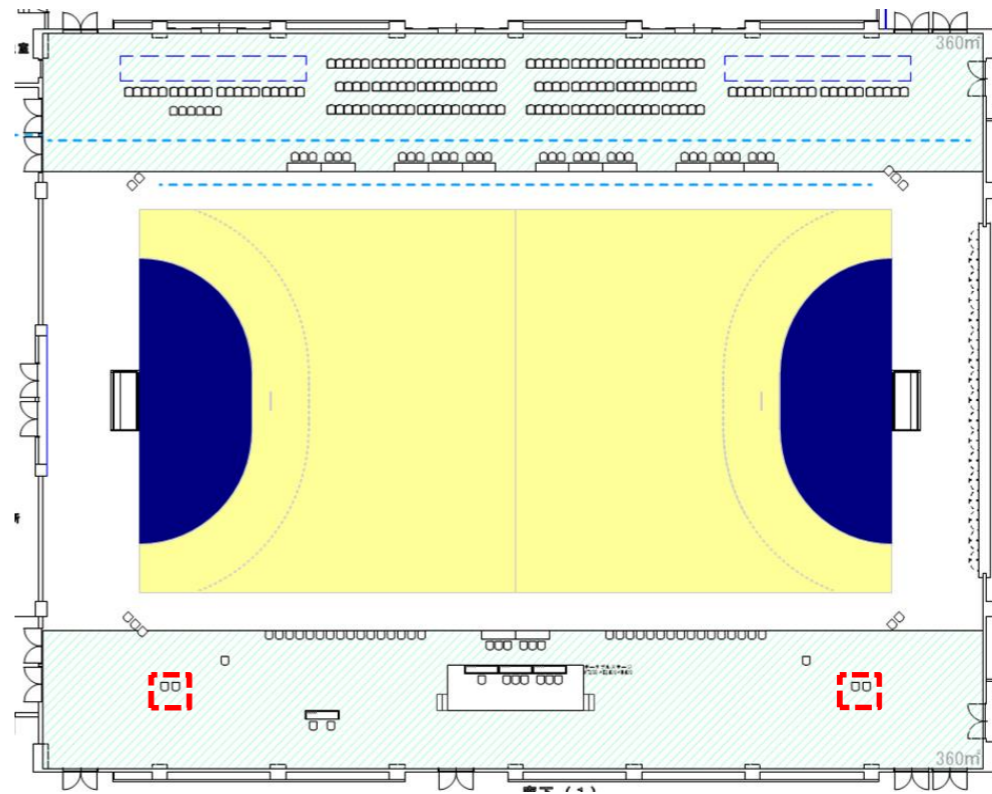

競技	番号	施設名称					設置エリア			
	1	競技本部								
No.	品名	仕様・規格	リース	製作	既存	引継	数量	単位	備考	
1	長机				○		6	台		
2	折畳椅子				○		18	脚		
3	ホワイトボード				○		1	台	実行委員会持込品	
4	整理棚		○				2	台		
5	ノートパソコン		○				1	台		
6	モバイルWi-Fiルーター		○				1	式		
7	電波時計		○				1	台		
8	IP無線機		○				1	台	ナンバリング含む	
9										
10										
11										
12										
13										
14										
15										
16										
17										
18										
19										
20										
21										
22										
23										
24										
25										
26										
27										

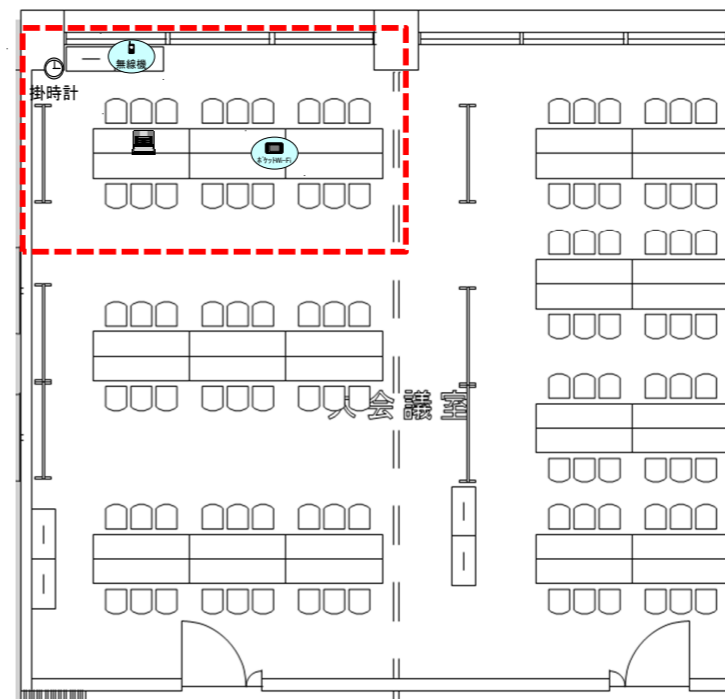

競技	番号	施設名称					設置エリア		
	2	記録本部・筆耕室							
No.	品名	仕様・規格	リース	製作	既存	引継	数量	単位	備考
1	長机				○		4	台	
2	折畳椅子				○		12	脚	
3	ホワイトボード				○		1	台	
4	ノートパソコン		○				1	台	
5	モバイルWi-Fiルーター		○				1	式	
6									
7									
8									
9									
10									
11									
12									
13									
14									
15									
16									
17									
18									
19									
20									
21									
22									
23									
24									
25									
26									
27									

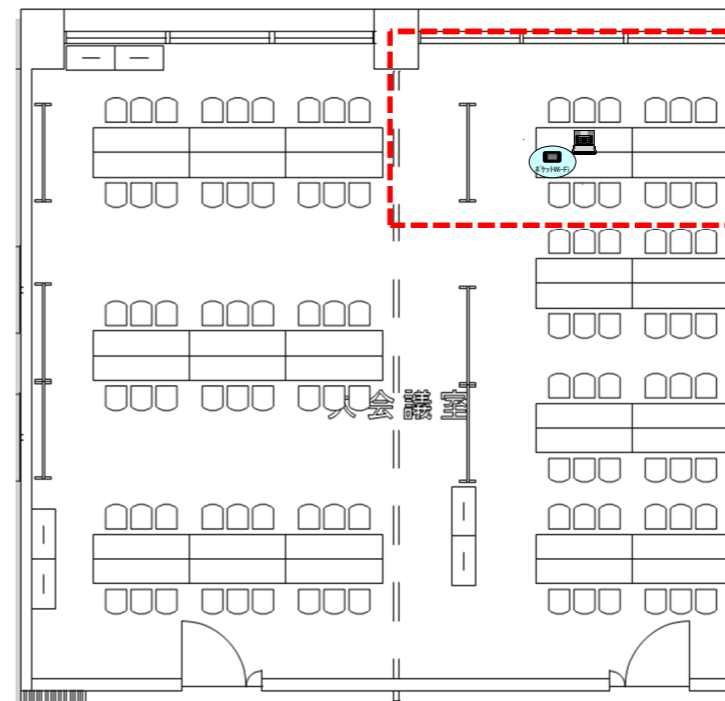

競技	番号	施設名称					設置エリア		
	3	競技役員控室							
No.	品名	仕様・規格	リース	製作	既存	引継	数量	単位	備考
1	長机				○		12	台	
2	折畳椅子				○		36	脚	
3	ホワイトボード				○		2	台	
4	整理棚		○				2	台	
5									
6									
7									
8									
9									
10									
11									
12									
13									
14									
15									
16									
17									
18									
19									
20									
21									
22									
23									
24									
25									
26									
27									

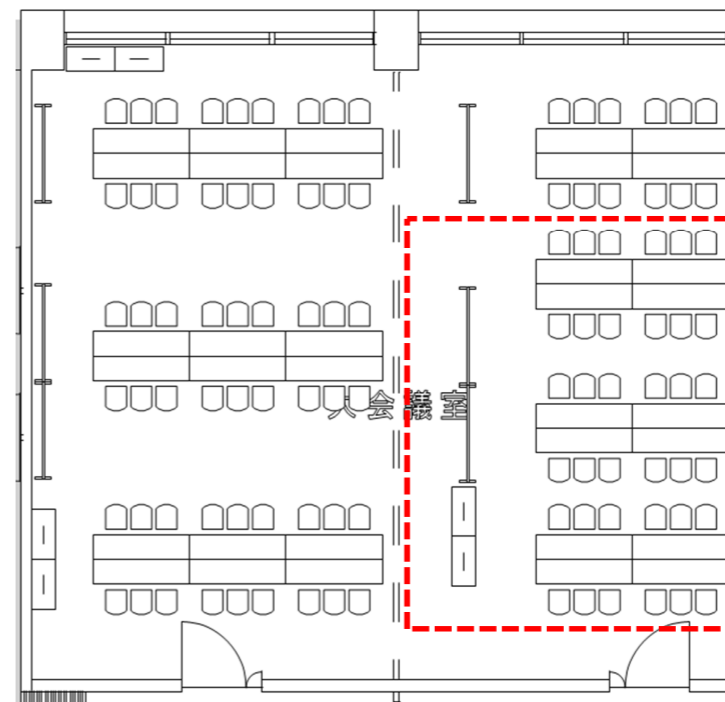

競技	番号	施設名称					設置エリア			
	4	審判員控室								
No.	品名	仕様・規格	リース	製作	既存	引継	数量	単位	備考	
1	長机				○		4	台		
2	折畳椅子				○		12	脚		
3	ホワイトボード				○		1	台		
4	整理棚		○				1	台		
5										
6										
7										
8										
9										
10										
11										
12										
13										
14										
15										
16										
17										
18										
19										
20										
21										
22										
23										
24										
25										
26										
27										

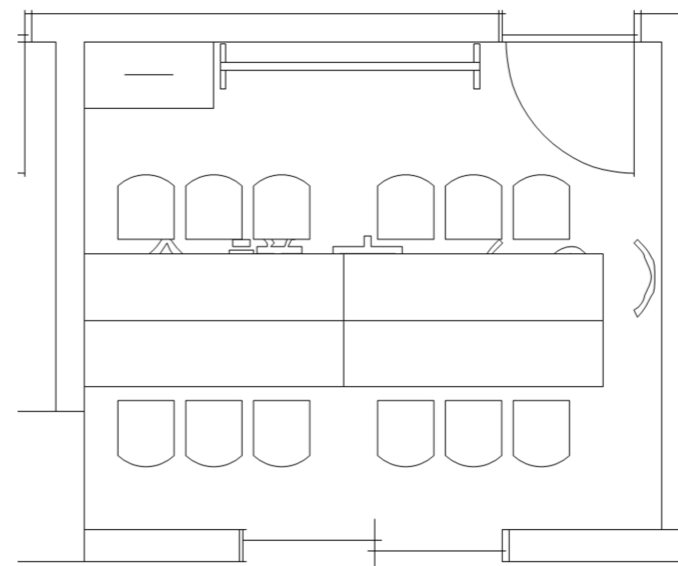

競技	番号	施設名称					設置エリア			
	5	来賓・大会役員控室								
No.	品名	仕様・規格	リース	製作	既存	引継	数量	単位	備考	
1	長机				○		6	台		
2	折畳椅子				○		18	脚		
3										
4										
5										
6										
7										
8										
9										
10										
11										
12										
13										
14										
15										
16										
17										
18										
19										
20										
21										
22										
23										
24										
25										
26										
27										

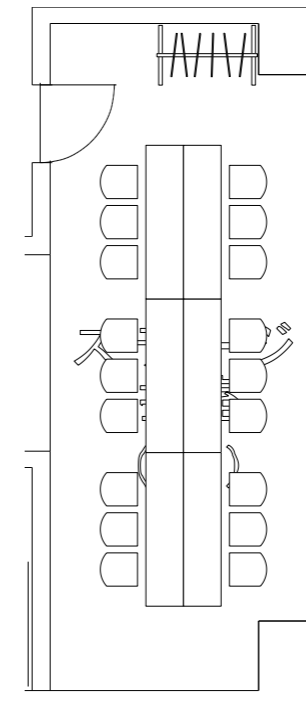

競技	番号	施設名称					設置エリア		
	6	実施本部							
No.	品名	仕様・規格	リース	製作	既存	引継	数量	単位	備考
1	長机				○		12	台	
2	折畳椅子				○		36	脚	
3	ホワイトボード				○		2	台	実行委員会持込品
4	整理棚		○				2	台	
5	モバイルWi-Fiルーター		○				1	式	
6	電波時計		○				1	台	
7	IP無線機		○				1	台	ナンバリング含む
8									
9									
10									
11									
12									
13									
14									
15									
16									
17									
18									
19									
20									
21									
22									
23									
24									
25									
26									
27									

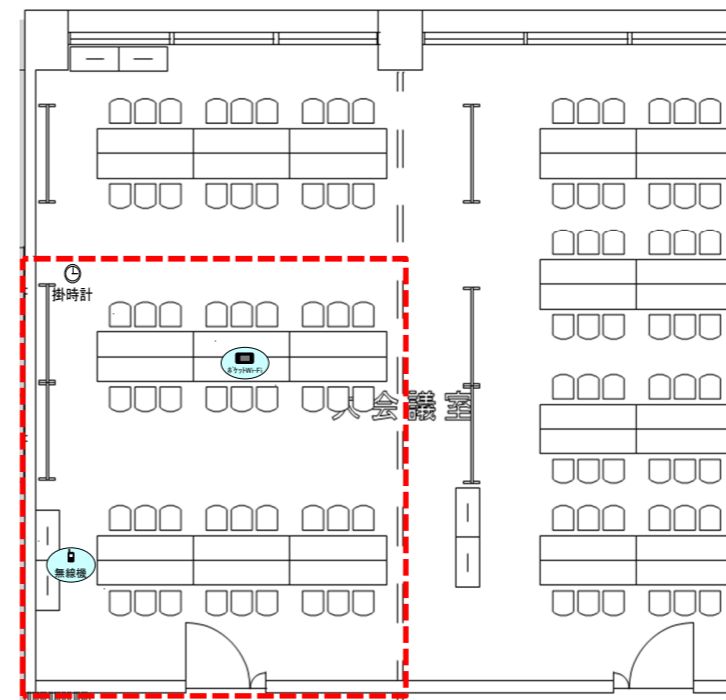

競技	番号	施設名称					設置エリア		
	7	救護室							
No.	品名	仕様・規格	リース	製作	既存	引継	数量	単位	備考
1	事務机				○		1	台	
2	折畳椅子				○		2	脚	
3	簡易ベット				○		3	台	
4	寝具セット		○				3	式	
5	布パーテーション		○				3	枚	
6	脱衣かご		○				3	個	
7	AED				○		1	台	
8	クーラーボックス		○				1	台	
9									
10									
11									
12									
13									
14									
15									
16									
17									
18									
19									
20									
21									
22									
23									
24									
25									
26									
27									

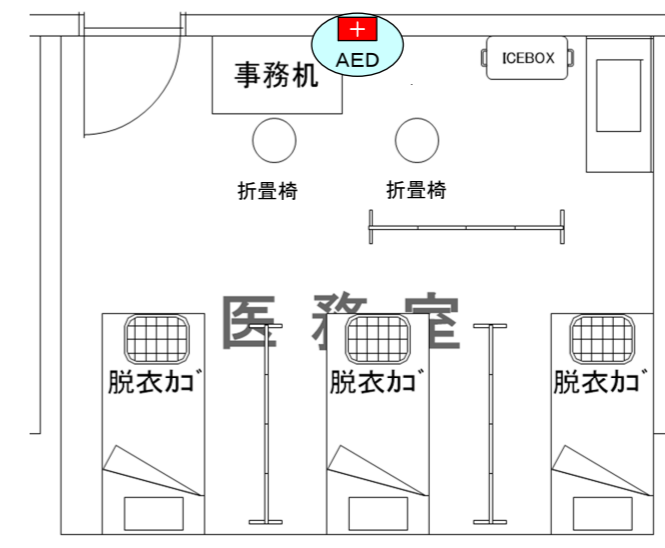

競技	番号	施設名称	設置エリア						
	8	競技補助員控室							
No.	品名	仕様・規格	リース	製作	既存	引継	数量	単位	備考
1	既存観客席利用								
2									
3									
4									
5									
6									
7									
8									
9									
10									
11									
12									
13									
14									
15									
16									
17									
18									
19									
20									
21									
22									
23									
24									
25									
26									
27									

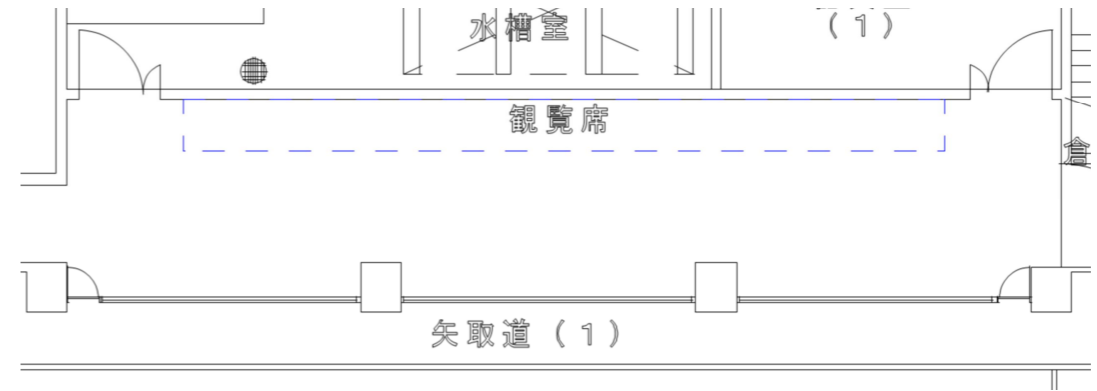

競技	番号	施設名称	設置エリア						
	9	競技会係員・補助員控室							
No.	品名	仕様・規格	リース	製作	既存	引継	数量	単位	備考
1	既存観客席利用								
2									
3									
4									
5									
6									
7									
8									
9									
10									
11									
12									
13									
14									
15									
16									
17									
18									
19									
20									
21									
22									
23									
24									
25									
26									
27									

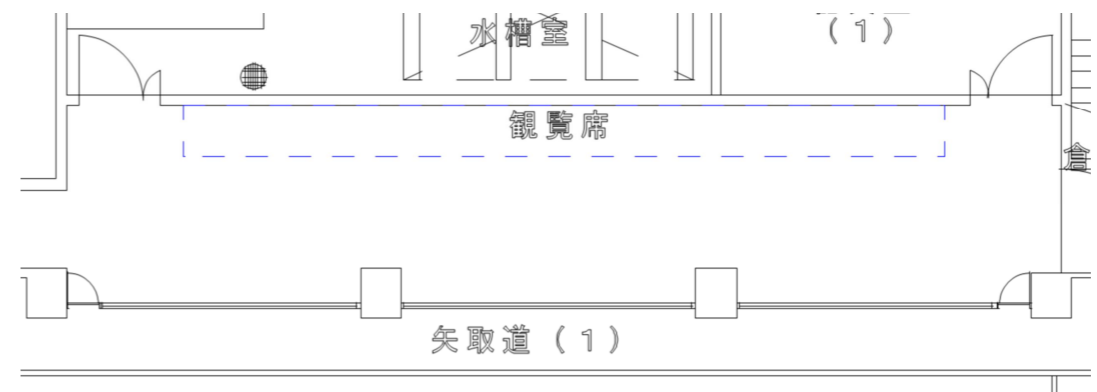

競技	番号	施設名称	設置エリア						
	10	大会関係者更衣室(男子)							
No.	品名	仕様・規格	リース	製作	既存	引継	数量	単位	備考
1	既存利用								
2									
3									
4									
5									
6									
7									
8									
9									
10									
11									
12									
13									
14									
15									
16									
17									
18									
19									
20									
21									
22									
23									
24									
25									
26									
27									

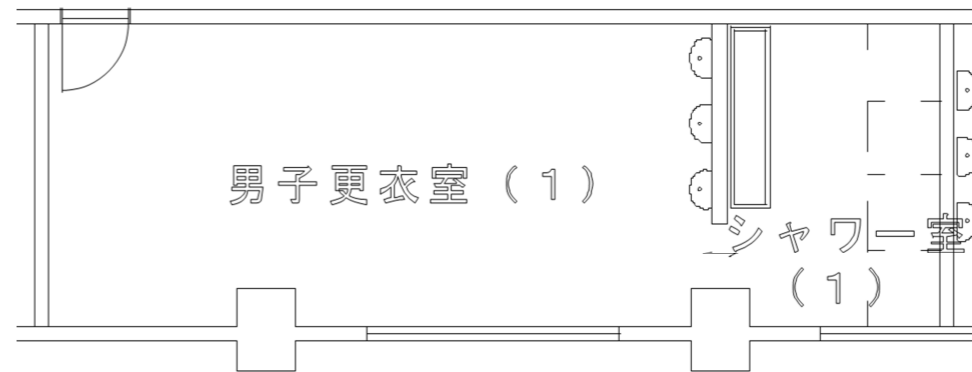

競技	番号	施設名称	設置エリア						
	11	大会関係者更衣室(女子)							
No.	品名	仕様・規格	リース	製作	既存	引継	数量	単位	備考
1	既存利用								
2									
3									
4									
5									
6									
7									
8									
9									
10									
11									
12									
13									
14									
15									
16									
17									
18									
19									
20									
21									
22									
23									
24									
25									
26									
27									

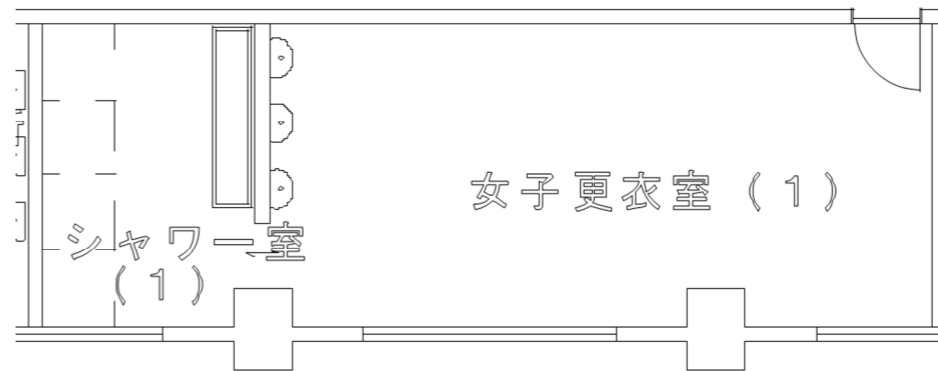

競技	番号	施設名称	設置エリア						
	12	選手用ドリンクコーナー							
No.	品名	仕様・規格	リース	製作	既存	引継	数量	単位	備考
1	長机	450×1800			○		2	台	
2	折畳椅子				○		4	脚	
3									
4									
5									
6									
7									
8									
9									
10									
11									
12									
13									
14									
15									
16									
17									
18									
19									
20									
21									
22									
23									
24									
25									
26									
27									

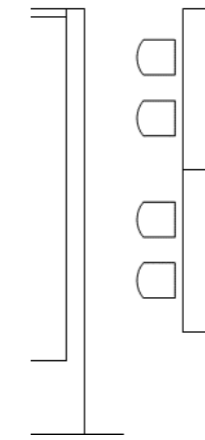

競技	番号	施設名称	設置エリア						
	13	インタビューコーナー							
No.	品名	仕様・規格	リース	製作	既存	引継	数量	単位	備考
1									
2									
3									
4									
5									
6									
7									
8									
9									
10									
11									
12									
13									
14									
15									
16									
17									
18									
19									
20									
21									
22									
23									
24									
25									
26									
27									

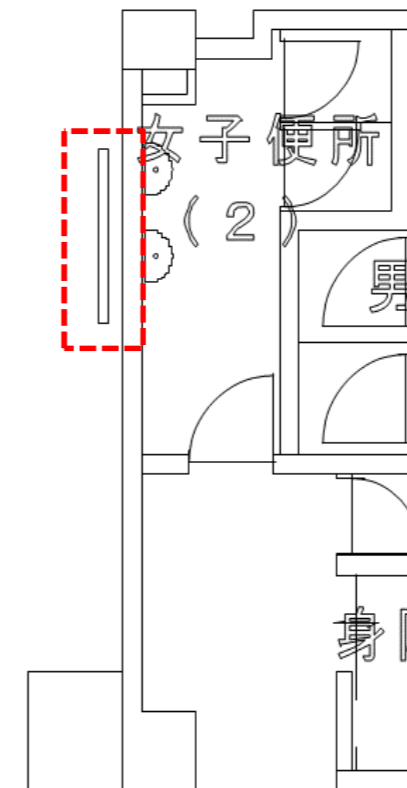

競技	番号	施設名称					設置エリア		
	14	記録速報所							
No.	品名	仕様・規格	リース	製作	既存	引継	数量	単位	備考
1	長机				○		1	台	
2									
3									
4									
5									
6									
7									
8									
9									
10									
11									
12									
13									
14									
15									
16									
17									
18									
19									
20									
21									
22									
23									
24									
25									
26									
27									

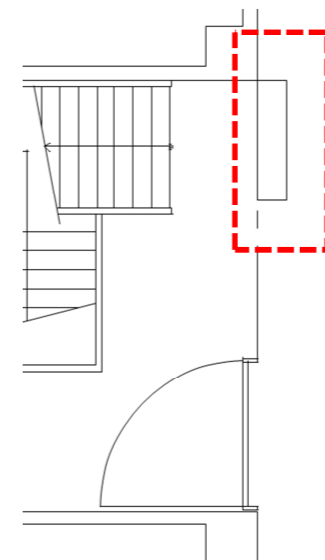

競技	番号	施設名称					設置エリア		
	15	トーナメント表							
No.	品名	仕様・規格	リース	製作	既存	引継	数量	単位	備考
1	トーナメント表			○			1	枚	看板工事にて計上
2									
3									
4									
5									
6									
7									
8									
9									
10									
11									
12									
13									
14									
15									
16									
17									
18									
19									
20									
21									
22									
23									
24									
25									
26									
27									

配置図参照

競技	番号	施設名称	設置エリア						
	16	選手・監督・関係者受付							
No.	品名	仕様・規格	リース	製作	既存	引継	数量	単位	備考
1	パイプテント	1.5K2K	○				1	張	
2	横幕	1.5K	○				2	枚	
3	横幕	2K	○				2	枚	
4	長机		○				2	台	
5	折畳椅子		○				4	脚	
6	工業用扇風機		○				1	台	
7									
8									
9									
10									
11									
12									
13									
14									
15									
16									
17									
18									
19									
20									
21									
22									
23									
24									
25									
26									
27									

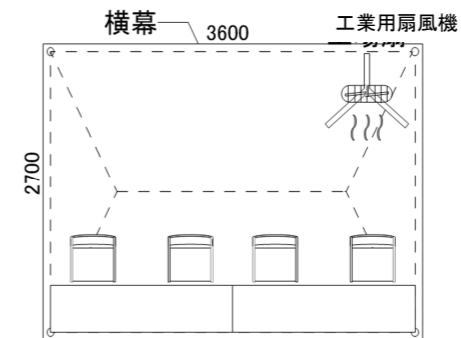

競技	番号	施設名称	設置エリア						
	17	テクニカルオフィシャル控室							
No.	品名	仕様・規格	リース	製作	既存	引継	数量	単位	備考
1	長机				○		6	台	
2	折畳椅子				○		18	脚	
3									
4									
5									
6									
7									
8									
9									
10									
11									
12									
13									
14									
15									
16									
17									
18									
19									
20									
21									
22									
23									
24									
25									
26									
27									

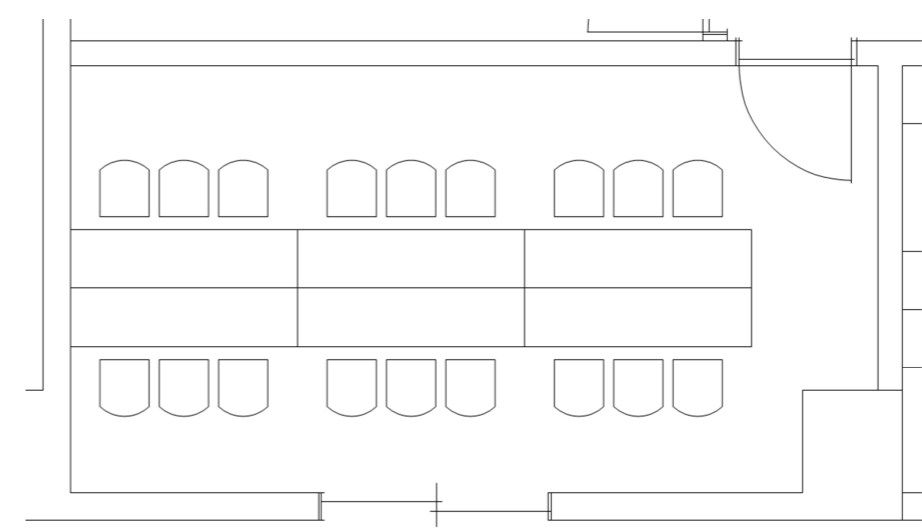

競技	番号	施設名称	設置エリア						
	18	プログラム販売所							
No.	品名	仕様・規格	リース	製作	既存	引継	数量	単位	備考
1	長机				○		1	台	
2	折畳椅子				○		2	脚	
3									
4									
5									
6									
7									
8									
9									
10									
11									
12									
13									
14									
15									
16									
17									
18									
19									
20									
21									
22									
23									
24									
25									
26									
27									

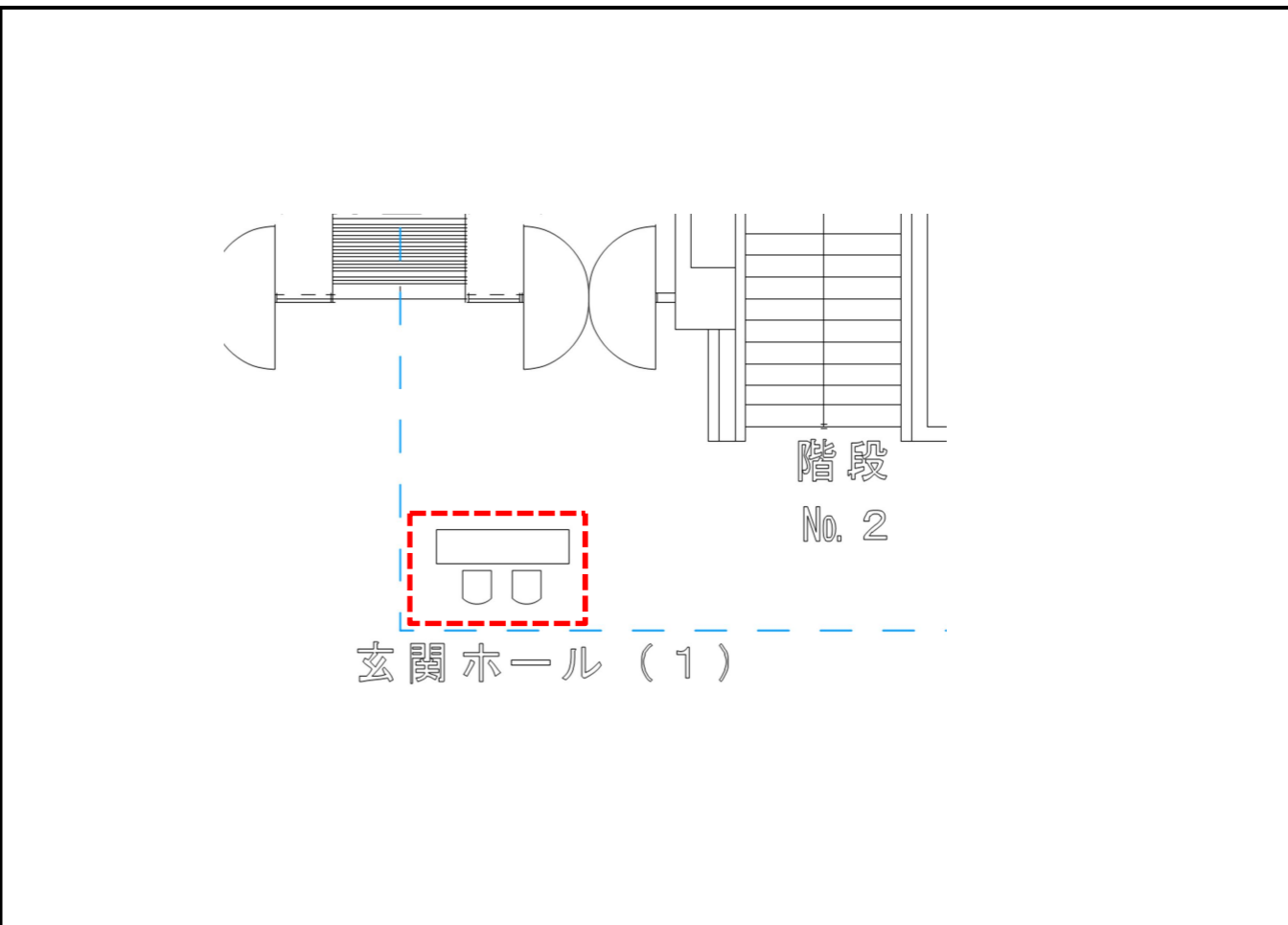

競技	番号	施設名称	設置エリア						
	19	一般観覧席							
No.	品名	仕様・規格	リース	製作	既存	引継	数量	単位	備考
1	折畳椅子				○		156	脚	
2	卓球フェンス				○		35	枚	
3									
4									
5									
6									
7									
8									
9									
10									
11									
12									
13									
14									
15									
16									
17									
18									
19									
20									
21									
22									
23									
24									
25									
26									
27									

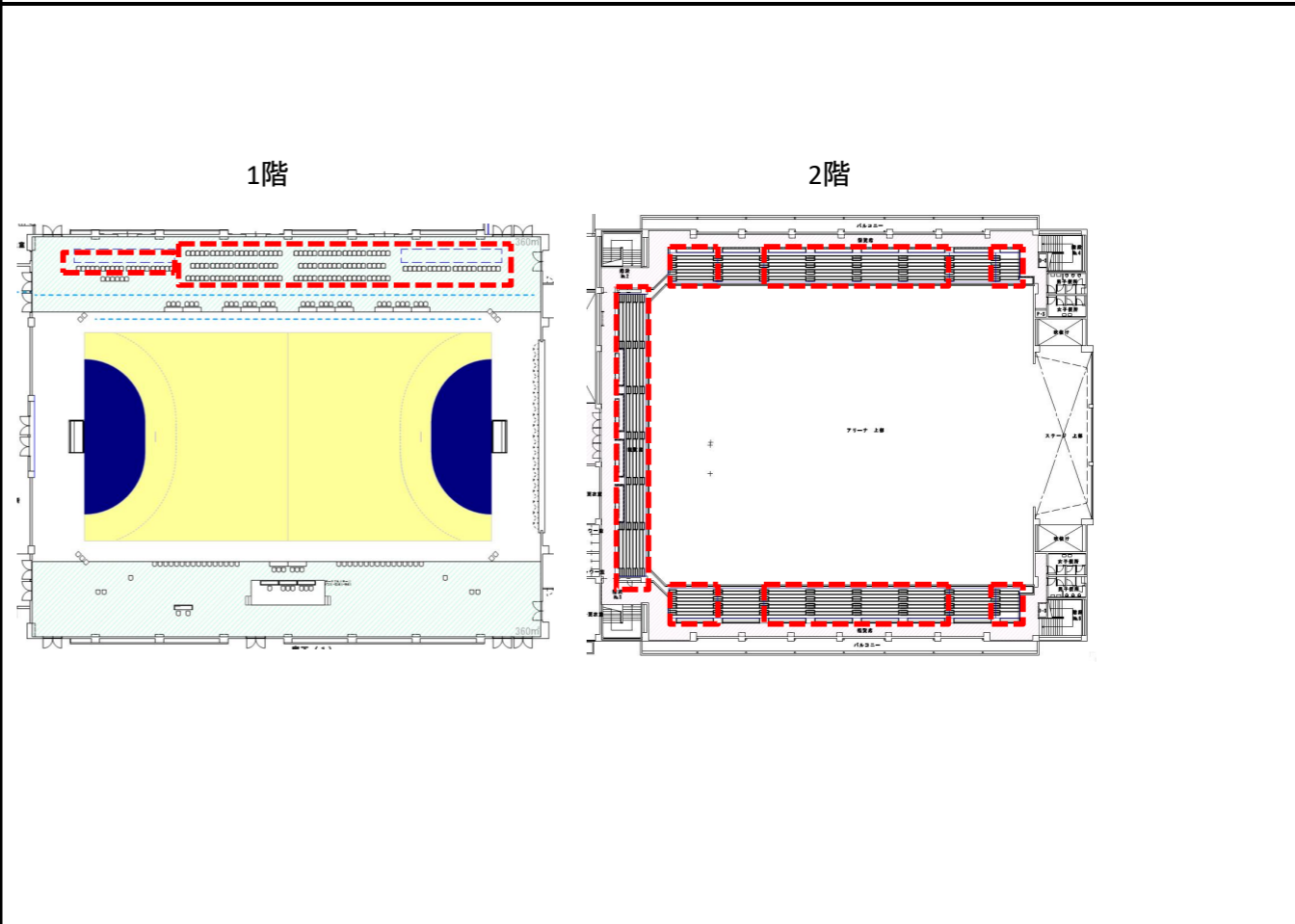

競技	番号	施設名称					設置エリア		
	20	チーム応援席							
No.	品名	仕様・規格	リース	製作	既存	引継	数量	単位	備考
1	既存利用								
2									
3									
4									
5									
6									
7									
8									
9									
10									
11									
12									
13									
14									
15									
16									
17									
18									
19									
20									
21									
22									
23									
24									
25									
26									
27									

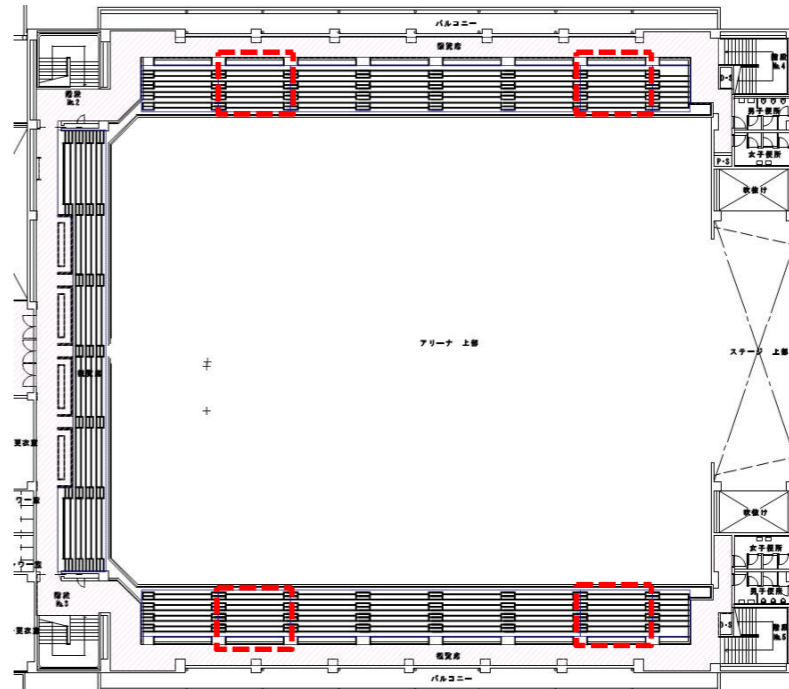

競技	番号	施設名称					設置エリア		
	21	福祉席							
No.	品名	仕様・規格	リース	製作	既存	引継	数量	単位	備考
1	折畳椅子				○		6	脚	
2									
3									
4									
5									
6									
7									
8									
9									
10									
11									
12									
13									
14									
15									
16									
17									
18									
19									
20									
21									
22									
23									
24									
25									
26									
27									

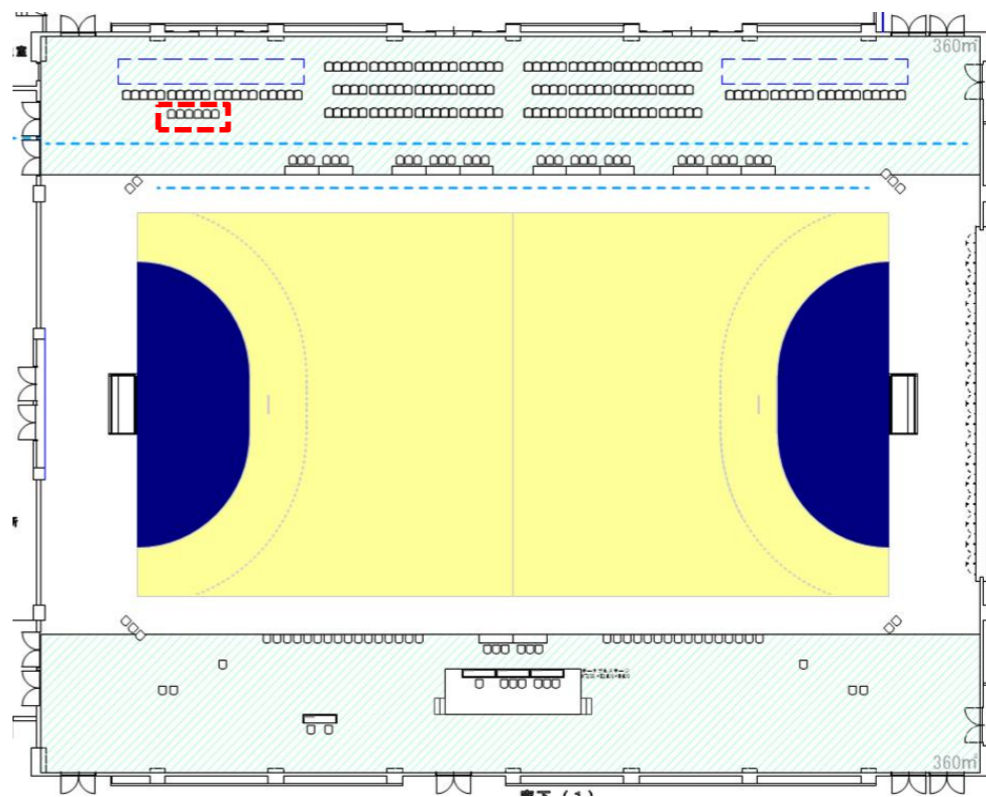

競技	番号	施設名称					設置エリア			
	22	弁当引換所								
No.	品名	仕様・規格	リース	製作	既存	引継	数量	単位	備考	
1	リハは設置しない									
2										
3										
4										
5										
6										
7										
8										
9										
10										
11										
12										
13										
14										
15										
16										
17										
18										
19										
20										
21										
22										
23										
24										
25										
26										
27										

競技	番号	施設名称					設置エリア			
	23	選手控所								
No.	品名	仕様・規格	リース	製作	既存	引継	数量	単位	備考	
1	パネルパーティション		○				130	枚		
2	パーティションドア		○				8	枚		
3	長机				○		8	台		
4	折畳椅子				○		120	脚		
5	据置きエアコン		○				6	台		
6										
7										
8										
9										
10										
11										
12										
13										
14										
15										
16										
17										
18										
19										
20										
21										
22										
23										
24										
25										
26										
27										

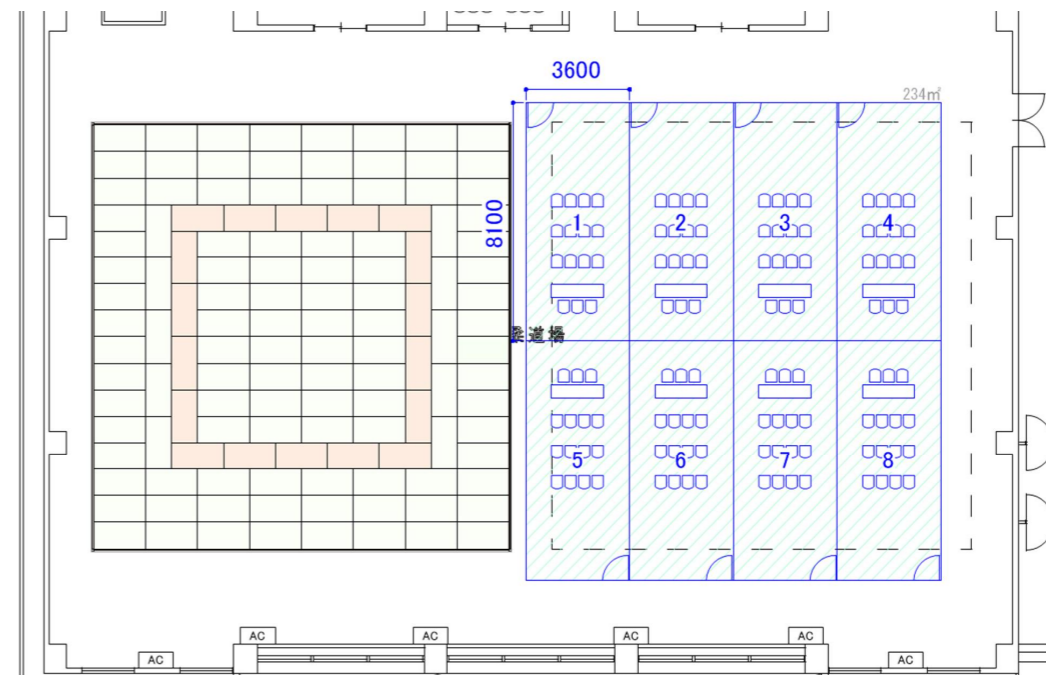

競技	番号	施設名称	設置エリア						
	24	アップ場							
No.	品名	仕様・規格	リース	製作	既存	引継	数量	単位	備考
1									
2									
3									
4									
5									
6									
7									
8									
9									
10									
11									
12									
13									
14									
15									
16									
17									
18									
19									
20									
21									
22									
23									
24									
25									
26									
27									

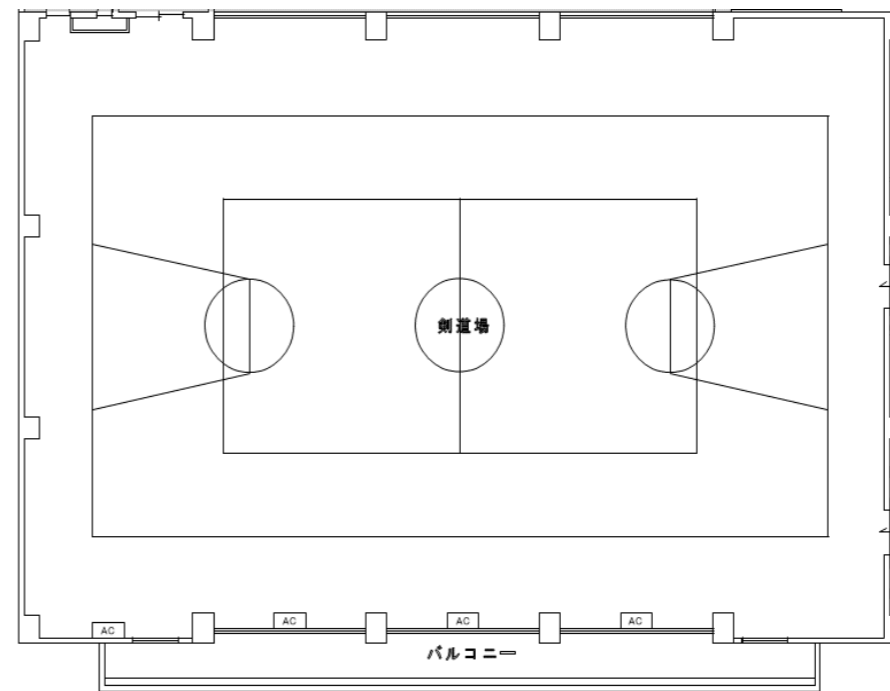

競技	番号	施設名称	設置エリア						
	25	会場案内図							
No.	品名	仕様・規格	リース	製作	既存	引継	数量	単位	備考
1	会場案内図			○			1	枚	看板工事にて計上
2									
3									
4									
5									
6									
7									
8									
9									
10									
11									
12									
13									
14									
15									
16									
17									
18									
19									
20									
21									
22									
23									
24									
25									
26									
27									

配置図参照

競技		番号	施設名称				設置エリア			
		26	ふるまいコーナー							
No.	品名	仕様・規格		リース	製作	既存	引継	数量	単位	備考
1	リハは設置しない									
2										
3										
4										
5										
6										
7										
8										
9										
10										
11										
12										
13										
14										
15										
16										
17										
18										
19										
20										
21										
22										
23										
24										
25										
26										
27										
競技		番号	施設名称				設置エリア			
		27	売店							
No.	品名	仕様・規格		リース	製作	既存	引継	数量	単位	備考
1	リハは設置しない									
2										
3										
4										
5										
6										
7										
8										
9										
10										
11										
12										
13										
14										
15										
16										
17										
18										
19										
20										
21										
22										
23										
24										
25										
26										
27										

競技		番号	施設名称				設置エリア			
		28	一般休憩所							
No.	品名	仕様・規格		リース	製作	既存	引継	数量	単位	備考
1	リハは設置しない									
2										
3										
4										
5										
6										
7										
8										
9										
10										
11										
12										
13										
14										
15										
16										
17										
18										
19										
20										
21										
22										
23										
24										
25										
26										
27										
競技		番号	施設名称				設置エリア			
		29	無料ドリンクコーナー							
No.	品名	仕様・規格		リース	製作	既存	引継	数量	単位	備考
1	リハは設置しない									
2										
3										
4										
5										
6										
7										
8										
9										
10										
11										
12										
13										
14										
15										
16										
17										
18										
19										
20										
21										
22										
23										
24										
25										
26										
27										

競技	番号	施設名称					設置エリア		
	30	受付案内所							
No.	品名	仕様・規格	リース	製作	既存	引継	数量	単位	備考
1	リハは設置しない								
2									
3									
4									
5									
6									
7									
8									
9									
10									
11									
12									
13									
14									
15									
16									
17									
18									
19									
20									
21									
22									
23									
24									
25									
26									
27									

競技	番号	施設名称					設置エリア		
	31	バス乗降所							
No.	品名	仕様・規格	リース	製作	既存	引継	数量	単位	備考
1	パイプテント	1.5K2K	○				1	張	
2	横幕	1.5K	○				2	枚	
3	横幕	2K	○				2	枚	
4	折畳椅子		○				1	脚	
5									
6									
7									
8									
9									
10									
11									
12									
13									
14									
15									
16									
17									
18									
19									
20									
21									
22									
23									
24									
25									
26									
27									

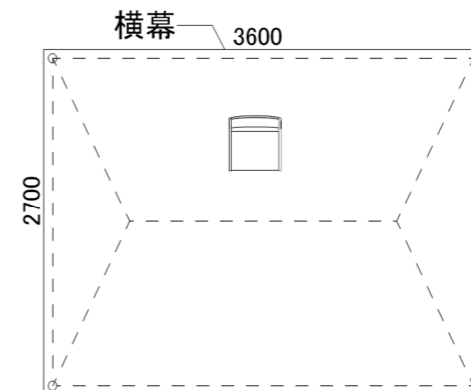

競技	番号	施設名称	設置エリア						
	32	ごみ集積所							
No.	品名	仕様・規格	リース	製作	既存	引継	数量	単位	備考
1	パイプテント	1.5K2K	○				1	張	
2	横幕	1.5K	○				2	枚	
3	横幕	2K	○				2	枚	
4	ブルーシート		○				1	枚	
5									
6									
7									
8									
9									
10									
11									
12									
13									
14									
15									
16									
17									
18									
19									
20									
21									
22									
23									
24									
25									
26									
27									

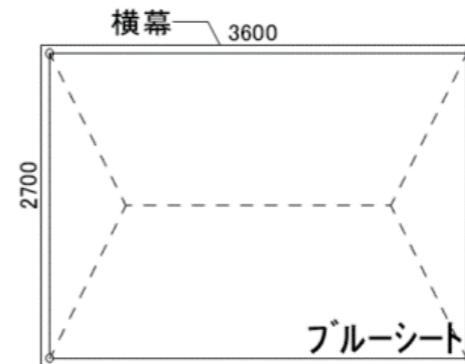

競技	番号	施設名称	設置エリア						
	33	喫煙所							
No.	品名	仕様・規格	リース	製作	既存	引継	数量	単位	備考
1	既存利用								
2									
3									
4									
5									
6									
7									
8									
9									
10									
11									
12									
13									
14									
15									
16									
17									
18									
19									
20									
21									
22									
23									
24									
25									
26									
27									

配置図参照

競技		番号	施設名称				設置エリア			
		34	駐車場係控所							
No.	品名	仕様・規格		リース	製作	既存	引継	数量	単位	備考
1	リハは設置しない									
2										
3										
4										
5										
6										
7										
8										
9										
10										
11										
12										
13										
14										
15										
16										
17										
18										
19										
20										
21										
22										
23										
24										
25										
26										
27										

競技		番号	施設名称				設置エリア			
		35	一般駐車場							
No.	品名	仕様・規格		リース	製作	既存	引継	数量	単位	備考
1	リハは設置しない									
2										
3										
4										
5										
6										
7										
8										
9										
10										
11										
12										
13										
14										
15										
16										
17										
18										
19										
20										
21										
22										
23										
24										
25										
26										
27										

競技		番号	施設名称				設置エリア			
		36	関係者駐車場							
No.	品名	仕様・規格		リース	製作	既存	引継	数量	単位	備考
1										
2										
3										
4										
5										
6										
7										
8										
9										
10										
11										
12										
13										
14										
15										
16										
17										
18										
19										
20										
21										
22										
23										
24										
25										
26										
27										
競技		番号	施設名称				設置エリア			
		37	ADチェック							
No.	品名	仕様・規格		リース	製作	既存	引継	数量	単位	備考
1	折畳椅子					○		2	脚	
2	卓球フェンス					○		15	枚	
3										
4										
5										
6										
7										
8										
9										
10										
11										
12										
13										
14										
15										
16										
17										
18										
19										
20										
21										
22										
23										
24										
25										
26										
27										

配置図参照

配置図参照

競技		番号	施設名称				設置エリア			
		38	電気工事							
No.	品名	仕様・規格		リース	製作	既存	引継	数量	単位	備考
1	【競技周辺】									
2	600Vビニル絶縁電線	IV 5.5sq		○				15	m	
3	600Vビニル絶縁電線	IV 8sq		○				60	m	
4	600V架橋ポリエチレン絶縁ビニルシースケーブル	CV 14sq-4C		○				168	m	
5	トリプルコア形架橋ポリエチレンケーブル	600V CVT 60sq		○				60	m	
6	動力盤	MG2-1		○				1	面	
7	動力盤	MG3-1		○				1	面	
8	発電機	G2 60KVA		○				1	台	
9	発電機	G3 60KVA		○				1	台	
10	接地材料	ED		○				2	式	
11	消火器(ABC粉末10型)	ｽﾀﾝﾄﾞ 共		○				2	本	
12	消防手続及書類作成費			○				1	式	
13										
14										
15	【競技会場内】									
16	600Vビニル絶縁電線	IV 5.5sq		○				10	m	
17	600Vビニル絶縁ビニルシースケーブル	VVF 1.6mm-3C		○				13	m	
18	600Vビニル絶縁ビニルシースケーブル	VVF 2.0mm-3C		○				223	m	
19	600V架橋ポリエチレン絶縁ビニルシースケーブル	CV 14sq-4C		○				20	m	
20	電灯分電盤	LG1-1		○				1	面	
21	コンセント	2P15AEx2		○				24	個	
22	発電機	G1 25KVA		○				1	台	
23	接地材料	ED		○				1	式	
24	窓枠木板	1カ所		○				1	式	
25	消火器(ABC粉末10型)	ｽﾀﾝﾄﾞ 共		○				1	本	
26										
27										
競技		番号	施設名称				設置エリア			
		39	音響工事							
No.	品名	仕様・規格		リース	製作	既存	引継	数量	単位	備考
1										
2										
3										
4										
5										
6										
7										
8										
9										
10										
11										
12										
13										
14										
15										
16										
17										
18										
19										
20										
21										
22										
23										
24										
25										
26										
27										

競技		番号	施設名称				設置エリア			
		40	映像工事							
No.	品名	仕様・規格		リース	製作	既存	引継	数量	単位	備考
1	設置なし									
2										
3										
4										
5										
6										
7										
8										
9										
10										
11										
12										
13										
14										
15										
16										
17										
18										
19										
20										
21										
22										
23										
24										
25										
26										
27										
競技		番号	施設名称				設置エリア			
		41	看板工事							
No.	品名	仕様・規格		リース	製作	既存	引継	数量	単位	備考
1	立看板				○			1	枚	バス乗降所
2	立看板(両面)				○			1	枚	(歓迎)大会名
3	大会名看板				○			1	枚	
4	旗看板				○			4	枚	国旗/市旗/協会旗/県旗
5	会場案内図				○			1	枚	
6	トーナメント表				○			1	枚	
7	ブラカード(盤面のみ(両面))				○			20	枚	優勝/準優勝/3位/4位/チーム名
8	ブラカード枠のみ				○			4	枚	
9	修正作業・入稿作業							1	式	
10	ウエイト			○				2	個	実行委員会持込み看板用
11										
12										
13										
14										
15										
16										
17										
18										
19										
20										
21										
22										
23										
24										
25										
26										
27										

競技	番号	施設名称					設置エリア		
	42	その他							
No.	品名	仕様・規格	リース	製作	既存	引継	数量	単位	備考
1	床養生(1F)				○		954	m	
2	パネルパーテーション		○				8	枚	
3	防球マット		○				6	枚	
4									
5									
6									
7									
8									
9									
10									
11									
12									
13									
14									
15									
16									
17									
18									
19									
20									
21									
22									
23									
24									
25									
26									
27									

競技	番号	施設名称						設置エリア	リハーサル大会
	A	テクニカルオフィシャル席							
No.	品名	仕様・規格	リース	製作	既存	引継	数量	単位	備考
1	長机		○				2	台	
2	折畳椅子		○				6	脚	
3	長机囲い			○			1	式	
4									
5									
6									
7									
8									
9									
10									
11									
12									
13									
14									
15									
16									
17									
18									
19									
20									
21									
22									
23									
24									
25									
26									
27									

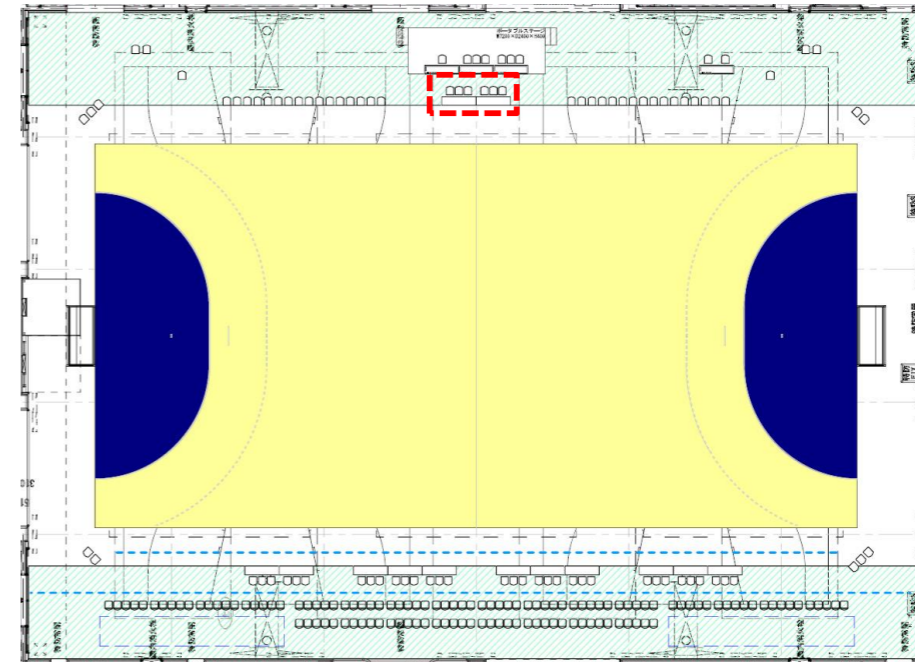

競技	番号	施設名称						設置エリア	リハーサル大会
	B	JHAオフィシャル席							
No.	品名	仕様・規格	リース	製作	既存	引継	数量	単位	備考
1	長机		○				1	台	
2	折畳椅子		○				1	脚	
3	白布		○				1	枚	
4	ポータブルステージ		○				6	台	
5	ステップ		○				2	式	
6									
7									
8									
9									
10									
11									
12									
13									
14									
15									
16									
17									
18									
19									
20									
21									
22									
23									
24									
25									
26									
27									

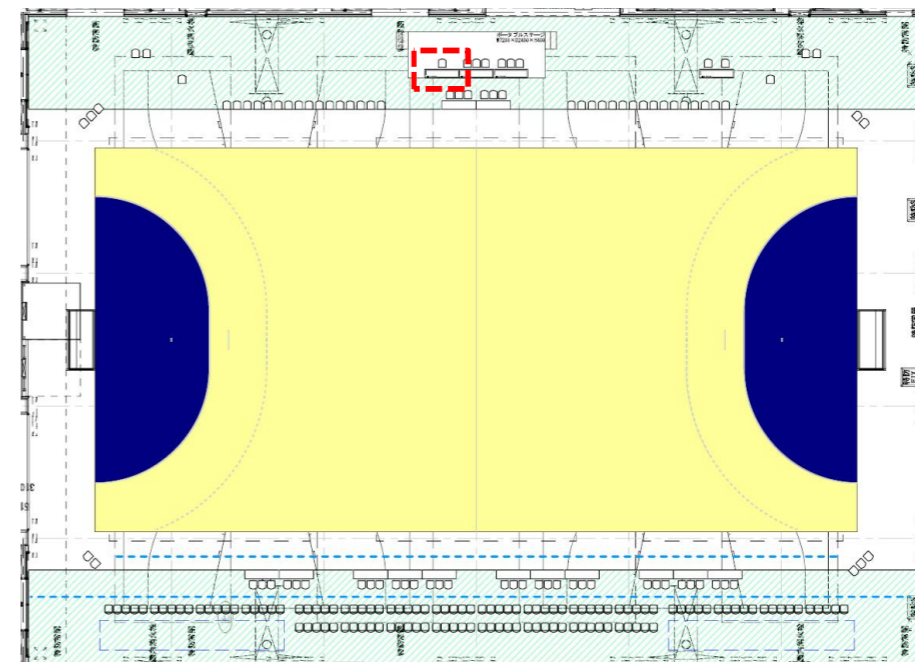

競技	番号	施設名称						設置エリア		
	C	公式記録席								
No.	品名	仕様・規格	リース	製作	既存	引継	数量	単位	備考	
1	長机		○				2	台		
2	折畳椅子		○				6	脚		
3	白布		○				2	枚		
4	ノートパソコン		○				1	台		
5	モバイルWi-Fiルーター		○				1	台		
6										
7										
8										
9										
10										
11										
12										
13										
14										
15										
16										
17										
18										
19										
20										
21										
22										
23										
24										
25										
26										
27										

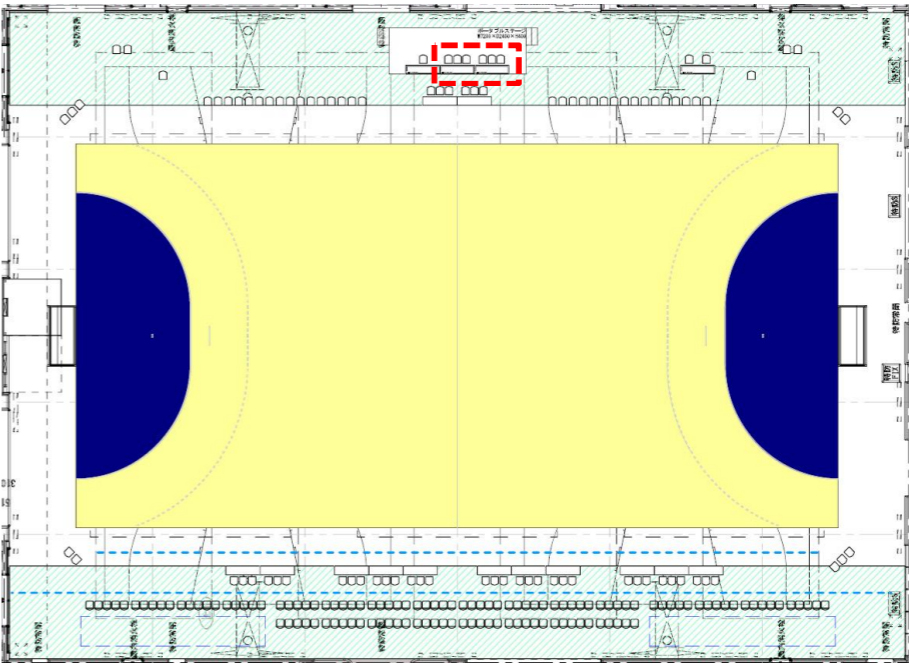

競技	番号	施設名称						設置エリア		
	D	放送席								
No.	品名	仕様・規格	リース	製作	既存	引継	数量	単位	備考	
1	リハは設置しない									
2										
3										
4										
5										
6										
7										
8										
9										
10										
11										
12										
13										
14										
15										
16										
17										
18										
19										
20										
21										
22										
23										
24										
25										
26										
27										

競技		番号	施設名称				設置エリア			
		E	競技役員席							
No.	品名	仕様・規格		リース	製作	既存	引継	数量	単位	備考
1	長机			○				3	台	
2	折畳椅子			○				9	脚	
3	卓球フェンス					○		27	枚	
4										
5										
6										
7										
8										
9										
10										
11										
12										
13										
14										
15										
16										
17										
18										
19										
20										
21										
22										
23										
24										
25										
26										
27										

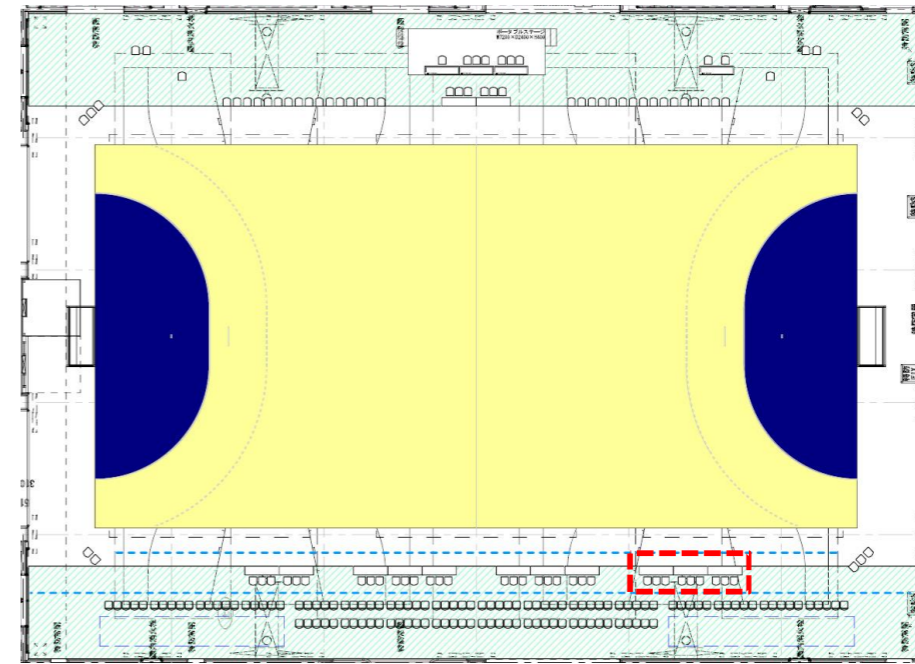

競技		番号	施設名称				設置エリア			
		F	審判員席							
No.	品名	仕様・規格		リース	製作	既存	引継	数量	単位	備考
1	長机			○				3	台	
2	折畳椅子			○				9	脚	
3										
4										
5										
6										
7										
8										
9										
10										
11										
12										
13										
14										
15										
16										
17										
18										
19										
20										
21										
22										
23										
24										
25										
26										
27										

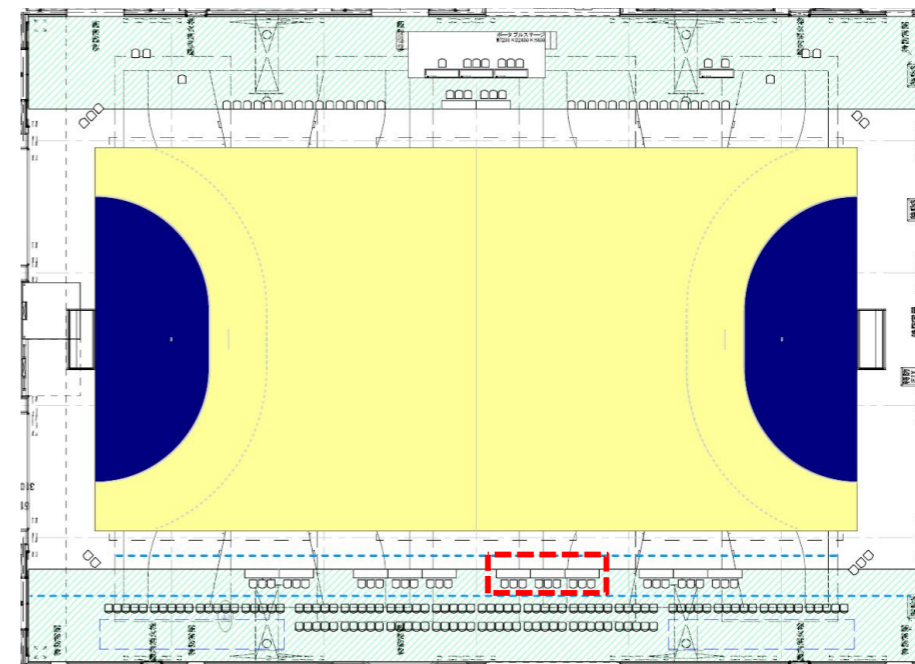

競技	番号	施設名称	設置エリア						
	G	来賓席							
No.	品名	仕様・規格	リース	製作	既存	引継	数量	単位	備考
1	長机		○				3	台	
2	折畳椅子		○				9	脚	
3									
4									
5									
6									
7									
8									
9									
10									
11									
12									
13									
14									
15									
16									
17									
18									
19									
20									
21									
22									
23									
24									
25									
26									
27									

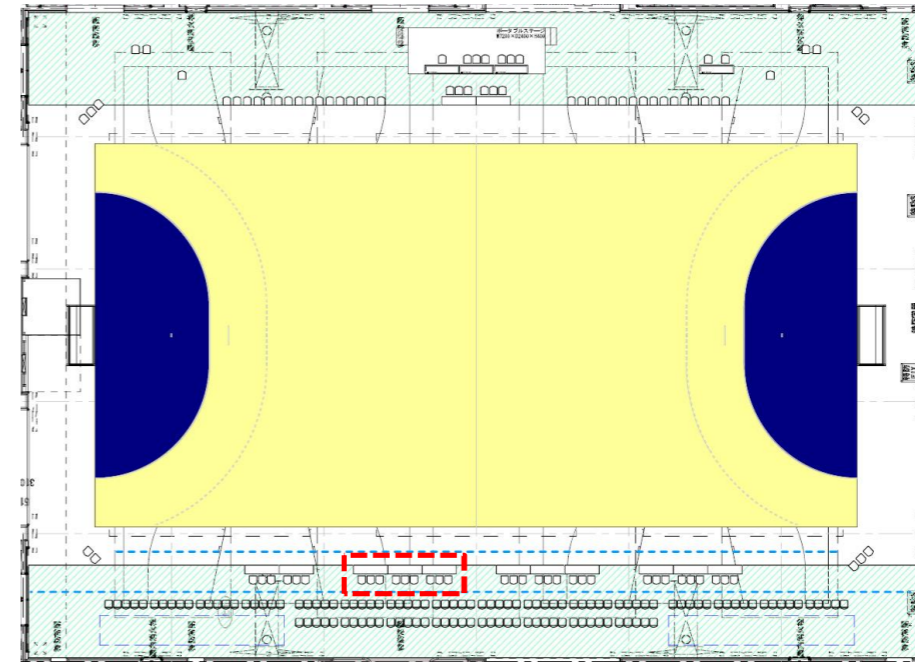

競技	番号	施設名称	設置エリア						
	H	救護席							
No.	品名	仕様・規格	リース	製作	既存	引継	数量	単位	備考
1	長机		○				1	台	
2	折畳椅子		○				2	脚	
3	車椅子		○				1	台	
4	担架		○				1	台	
5									
6									
7									
8									
9									
10									
11									
12									
13									
14									
15									
16									
17									
18									
19									
20									
21									
22									
23									
24									
25									
26									
27									

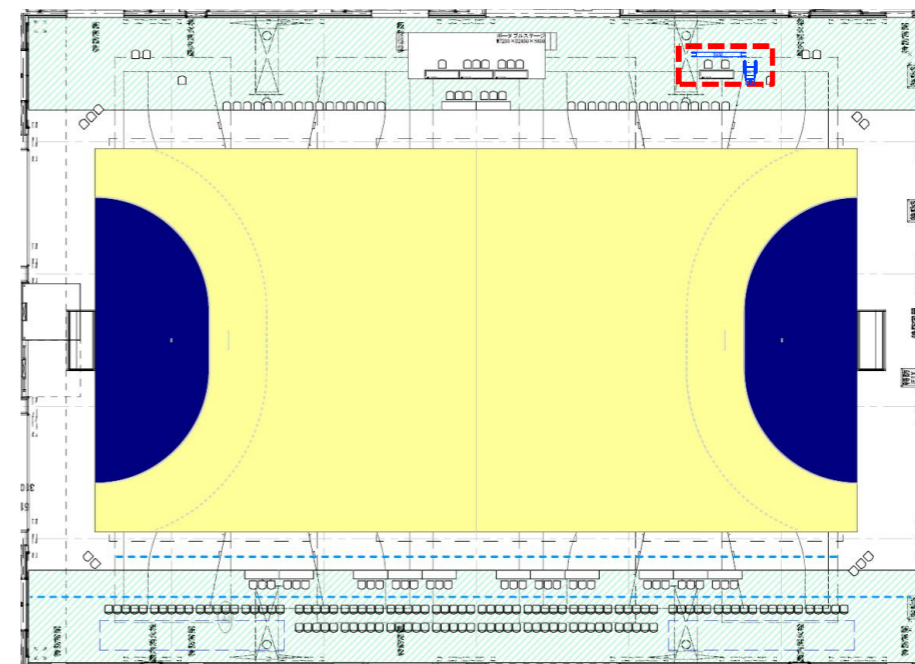

競技	番号	施設名称	設置エリア						
	I	報道員・視察員席							
No.	品名	仕様・規格	リース	製作	既存	引継	数量	単位	備考
1	長机		○				2	台	
2	折畳椅子		○				6	脚	
3									
4									
5									
6									
7									
8									
9									
10									
11									
12									
13									
14									
15									
16									
17									
18									
19									
20									
21									
22									
23									
24									
25									
26									
27									

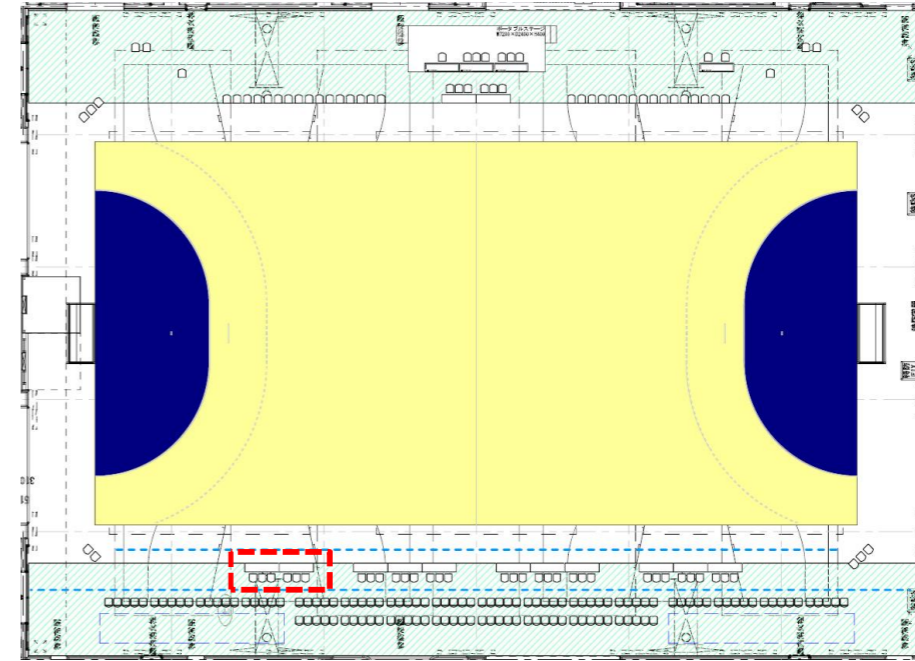

競技	番号	施設名称	設置エリア						
	J	選手席							
No.	品名	仕様・規格	リース	製作	既存	引継	数量	単位	備考
1	折畳椅子		○				32	脚	
2	プラカード台座		○				2	個	
3									
4									
5									
6									
7									
8									
9									
10									
11									
12									
13									
14									
15									
16									
17									
18									
19									
20									
21									
22									
23									
24									
25									
26									
27									

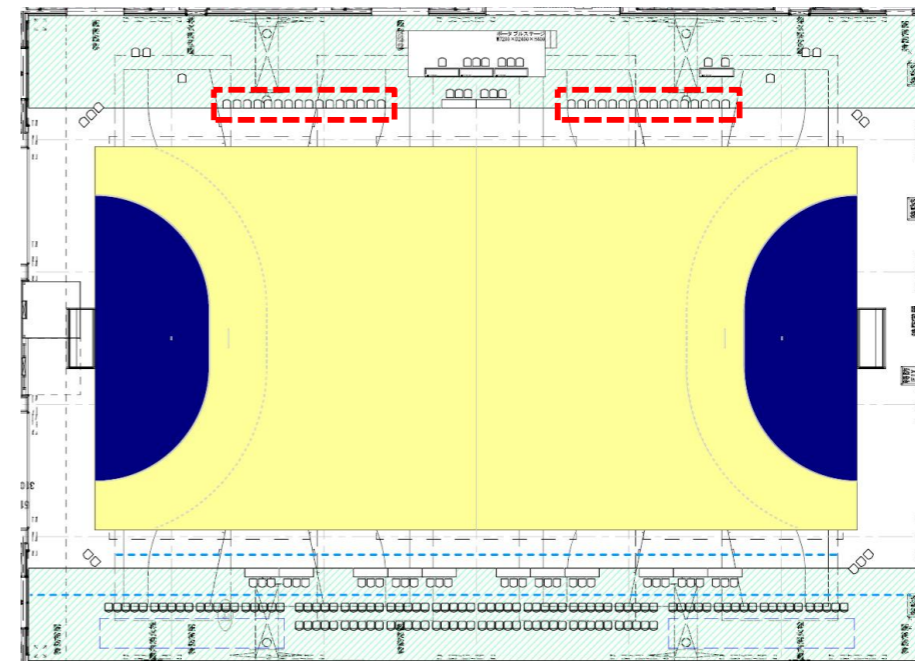

競技	番号	施設名称					設置エリア			
	K	トレーナー席								
No.	品名	仕様・規格	リース	製作	既存	引継	数量	単位	備考	
1	折畳椅子		○				2	脚		
2										
3										
4										
5										
6										
7										
8										
9										
10										
11										
12										
13										
14										
15										
16										
17										
18										
19										
20										
21										
22										
23										
24										
25										
26										
27										

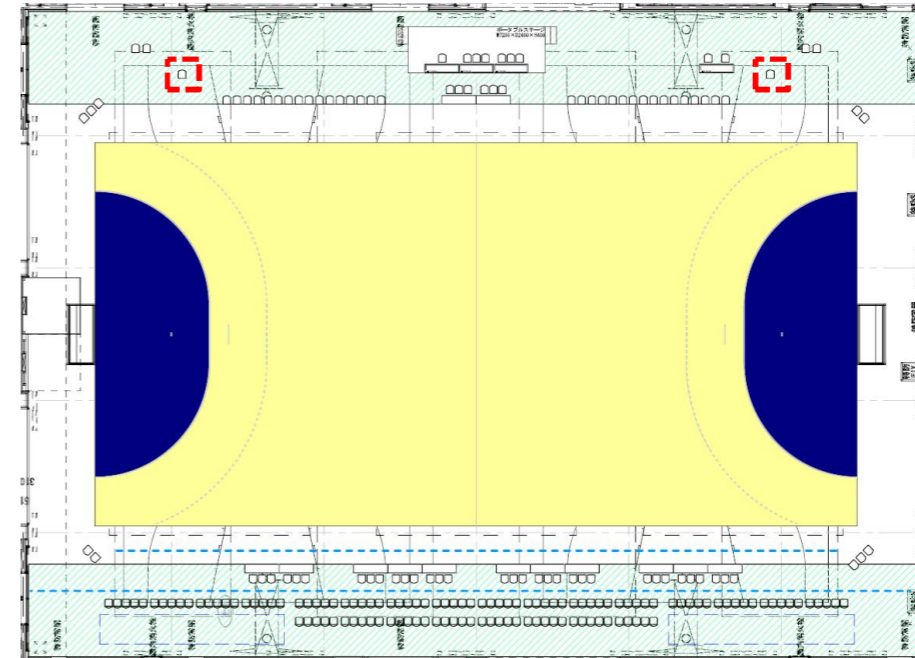

競技	番号	施設名称					設置エリア			
	L	コートキーパー席								
No.	品名	仕様・規格	リース	製作	既存	引継	数量	単位	備考	
1	折畳椅子		○				10	脚		
2										
3										
4										
5										
6										
7										
8										
9										
10										
11										
12										
13										
14										
15										
16										
17										
18										
19										
20										
21										
22										
23										
24										
25										
26										
27										

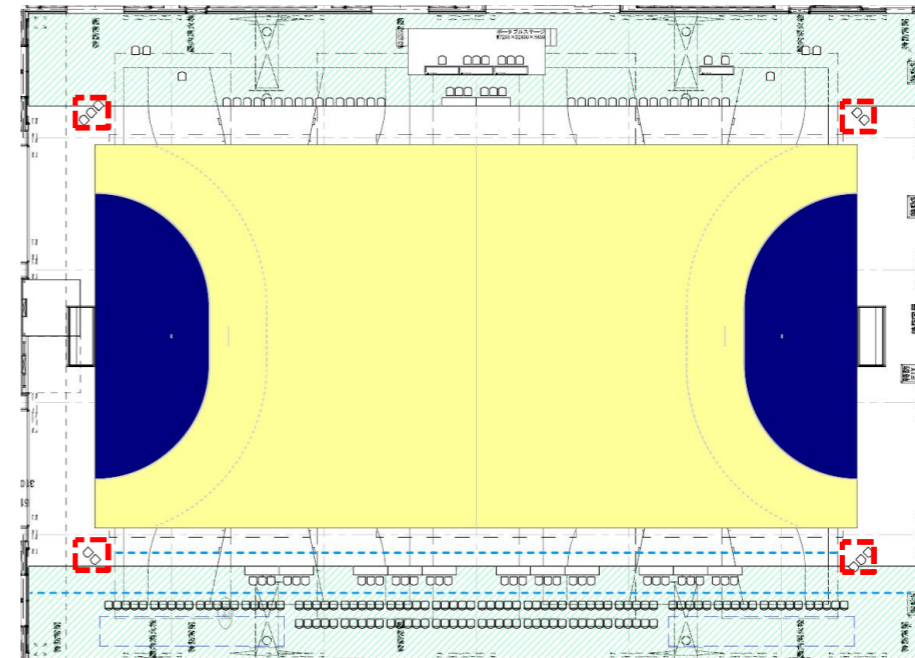

競技	番号	施設名称	設置エリア			
	M	失格者席				
No.	品名	仕様・規格	リース 製作 既存 引継	数量	単位	備考
1	折畳椅子		○			4脚
2						
3						
4						
5						
6						
7						
8						
9						
10						
11						
12						
13						
14						
15						
16						
17						
18						
19						
20						
21						
22						
23						
24						
25						
26						
27						

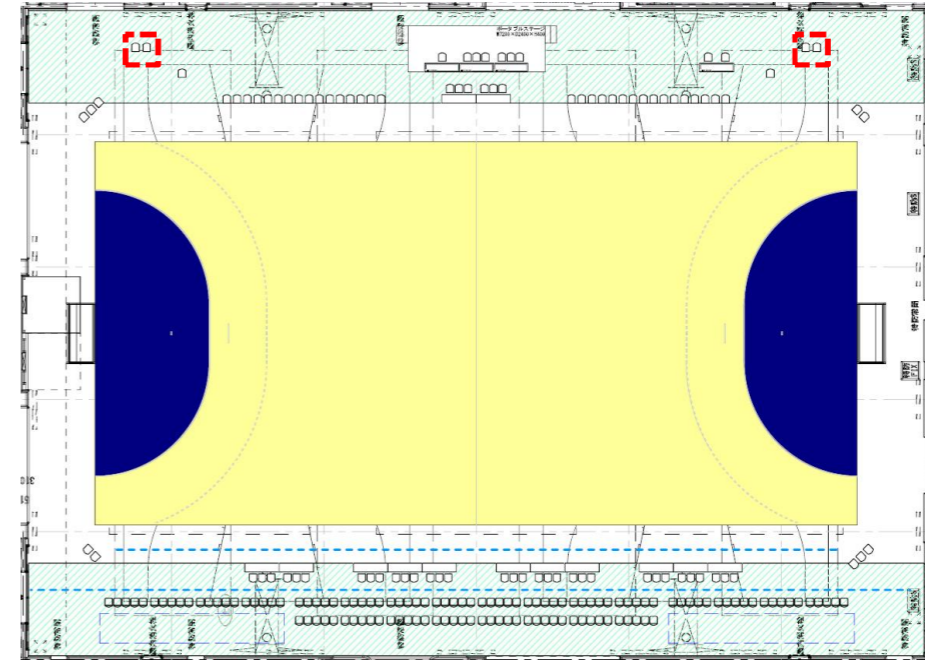

競技	番号	施設名称	設置エリア				
	1	競技本部					
No.	品名	仕様・規格	リース 製作 既存 引継	数量	単位	備考	
1	長机		○			4台	
2	折畳椅子			○		12脚	器具庫分使用
3	ホワイトボード		○			2台	
4	整理棚		○			2台	
5	ノートパソコン		○			1台	
6	モバイルWi-Fiルーター		○			1式	
7	電波時計		○			1台	
8	IP無線機		○			1台	ナンバリング含む
9							
10							
11							
12							
13							
14							
15							
16							
17							
18							
19							
20							
21							
22							
23							
24							
25							
26							
27							

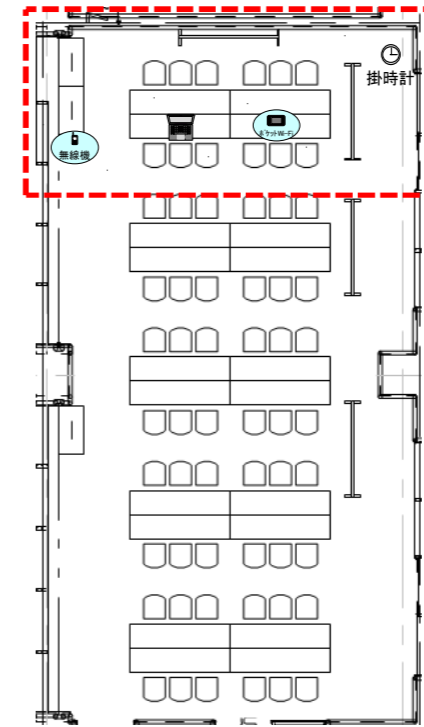

競技	番号	施設名称	設置エリア						
	2	記録本部・筆耕室							
No.	品名	仕様・規格	リース	製作	既存	引継	数量	単位	備考
1	長机		○				4	台	
2	折畳椅子				○		12	脚	器具庫分使用
3	ホワイトボード		○				1	台	
4	ノートパソコン		○				1	台	
5	モバイルWi-Fiルーター		○				1	式	
6									
7									
8									
9									
10									
11									
12									
13									
14									
15									
16									
17									
18									
19									
20									
21									
22									
23									
24									
25									
26									
27									

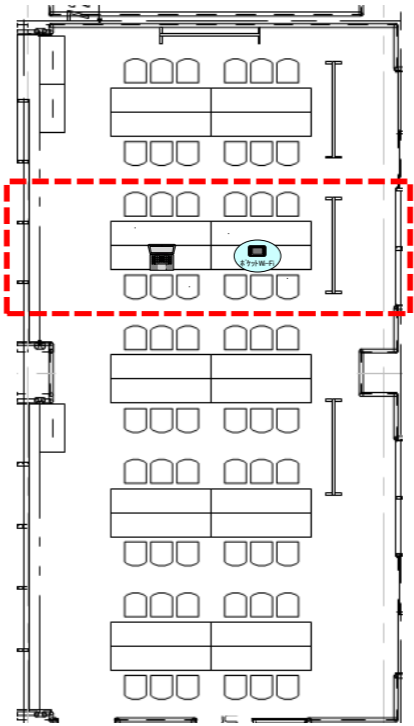

競技	番号	施設名称	設置エリア						
	3	競技役員控室							
No.	品名	仕様・規格	リース	製作	既存	引継	数量	単位	備考
1	長机		○				8	台	
2	折畳椅子				○		24	脚	器具庫分使用
3	ホワイトボード		○				1	台	
4	整理棚		○				1	台	
5									
6									
7									
8									
9									
10									
11									
12									
13									
14									
15									
16									
17									
18									
19									
20									
21									
22									
23									
24									
25									
26									
27									

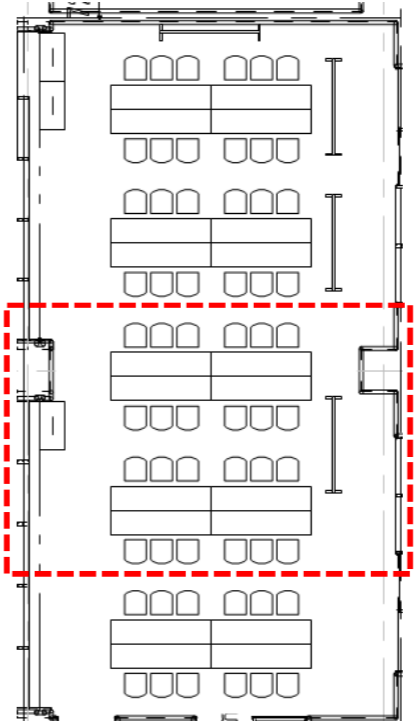

競技	番号	施設名称	設置エリア						
	4	審判員控室							
No.	品名	仕様・規格	リース	製作	既存	引継	数量	単位	備考
1	長机		○				4	台	
2	折畳椅子		○				12	脚	
3	ホワイトボード		○				1	台	
4	整理棚		○				1	台	
5	三つ折りパーテーション		○				2	枚	
6									
7									
8									
9									
10									
11									
12									
13									
14									
15									
16									
17									
18									
19									
20									
21									
22									
23									
24									
25									
26									
27									

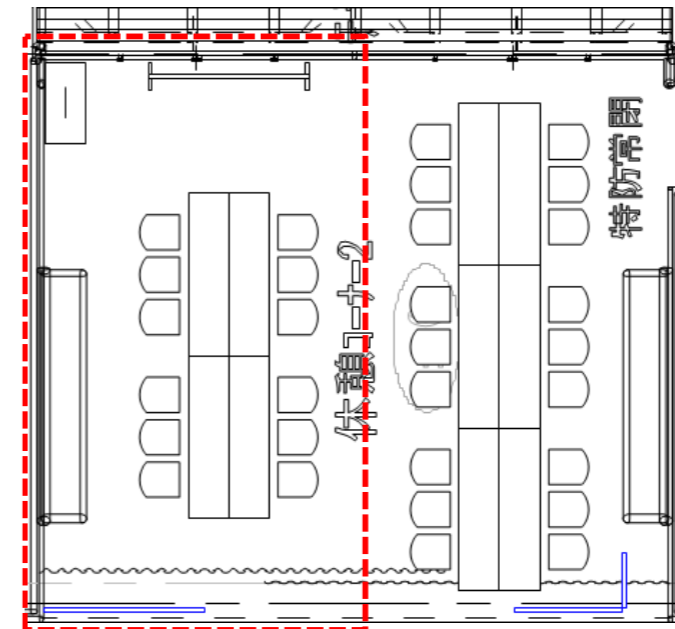

競技	番号	施設名称	設置エリア						
	5	来賓・大会役員控室							
No.	品名	仕様・規格	リース	製作	既存	引継	数量	単位	備考
1	長机		○				4	台	
2	折畳椅子				○		12	脚	器具庫分使用
3									
4									
5									
6									
7									
8									
9									
10									
11									
12									
13									
14									
15									
16									
17									
18									
19									
20									
21									
22									
23									
24									
25									
26									
27									

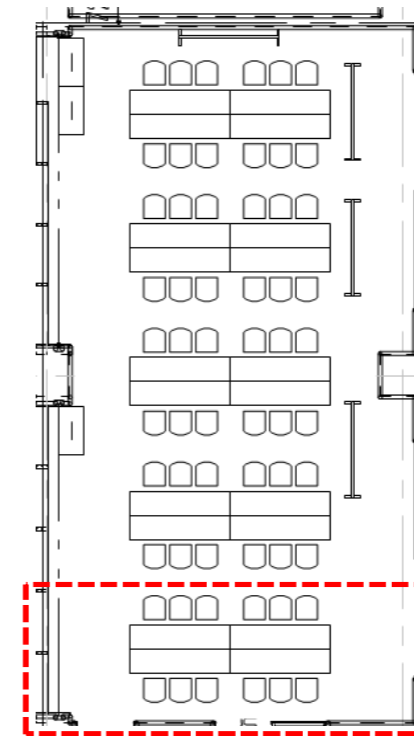

競技	番号	施設名称	設置エリア						
	6	実施本部							
No.	品名	仕様・規格	リース	製作	既存	引継	数量	単位	備考
1	長机		○				6	台	
2	折畳椅子		○				18	脚	
3	ホワイトボード		○				2	台	
4	整理棚		○				2	台	
5	モバイルWi-Fiルーター		○				1	式	
6	電波時計		○				1	台	
7	IP無線機		○				1	台	ナンバリング含む
8	三つ折りパーテーション		○				4	枚	
9									
10									
11									
12									
13									
14									
15									
16									
17									
18									
19									
20									
21									
22									
23									
24									
25									
26									
27									

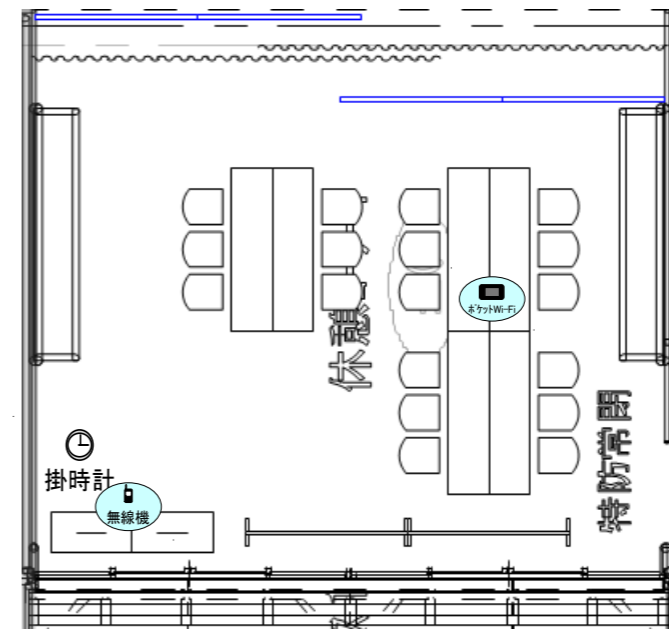

競技	番号	施設名称	設置エリア						
	7	救護室							
No.	品名	仕様・規格	リース	製作	既存	引継	数量	単位	備考
1	事務机		○				1	台	
2	折畳椅子				○		2	脚	器具庫分使用
3	簡易ベット		○				1	台	
4	寝具セット		○				1	式	
5	布パーテーション		○				1	枚	
6	脱衣かご		○				1	個	
7	AED				○		1	台	
8	クーラーボックス		○				1	台	
9									
10									
11									
12									
13									
14									
15									
16									
17									
18									
19									
20									
21									
22									
23									
24									
25									
26									
27									

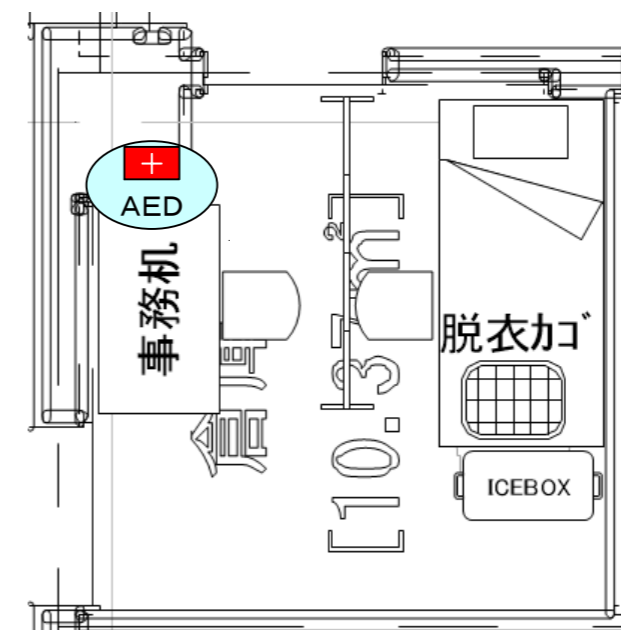

競技		番号	施設名称				設置エリア			
		8	競技補助員控室							
No.	品名	仕様・規格		リース	製作	既存	引継	数量	単位	備考
1	長机			○				6	台	
2	折畳椅子					○		18	脚	器具庫分使用
3										
4										
5										
6										
7										
8										
9										
10										
11										
12										
13										
14										
15										
16										
17										
18										
19										
20										
21										
22										
23										
24										
25										
26										
27										

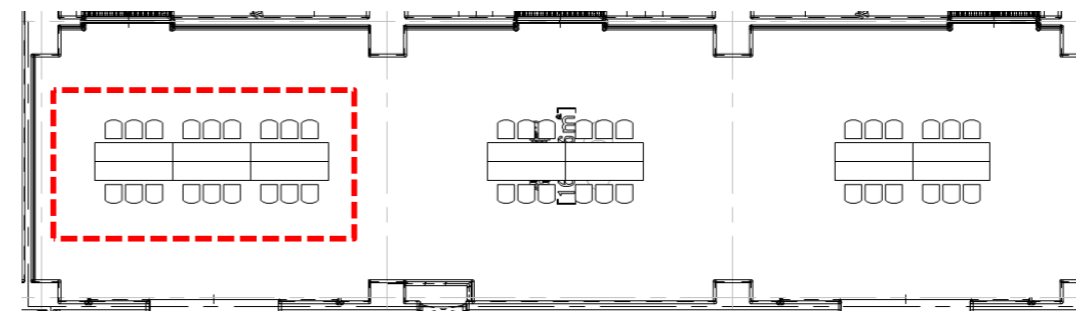

競技		番号	施設名称				設置エリア			
		9	競技会係員・補助員控室							
No.	品名	仕様・規格		リース	製作	既存	引継	数量	単位	備考
1	長机			○				8	台	
2	折畳椅子					○		24	脚	器具庫分使用
3										
4										
5										
6										
7										
8										
9										
10										
11										
12										
13										
14										
15										
16										
17										
18										
19										
20										
21										
22										
23										
24										
25										
26										
27										

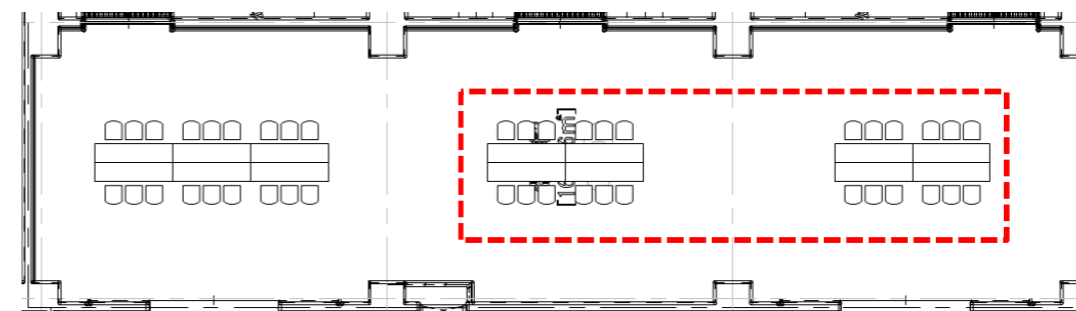

競技	番号	施設名称	設置エリア						
	10	大会関係者更衣室(男子)							
No.	品名	仕様・規格	リース	製作	既存	引継	数量	単位	備考
1	既存利用								
2									
3									
4									
5									
6									
7									
8									
9									
10									
11									
12									
13									
14									
15									
16									
17									
18									
19									
20									
21									
22									
23									
24									
25									
26									
27									

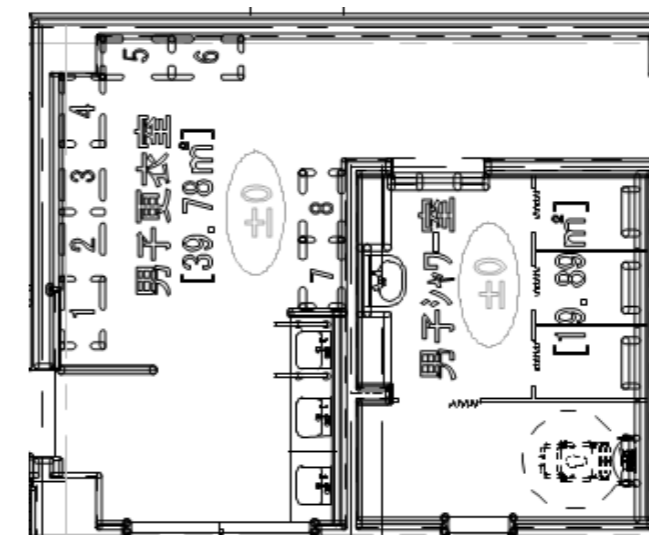

競技	番号	施設名称	設置エリア						
	11	大会関係者更衣室(女子)							
No.	品名	仕様・規格	リース	製作	既存	引継	数量	単位	備考
1	既存利用								
2									
3									
4									
5									
6									
7									
8									
9									
10									
11									
12									
13									
14									
15									
16									
17									
18									
19									
20									
21									
22									
23									
24									
25									
26									
27									

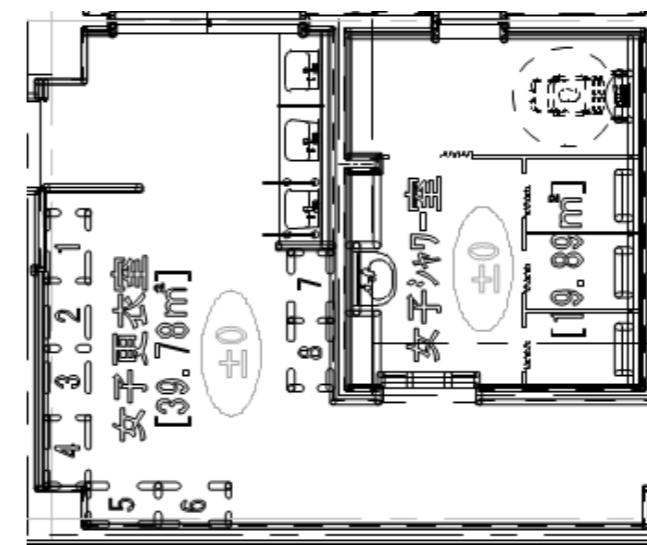

競技	番号	施設名称	設置エリア						
	12	選手用ドリンクコーナー							
No.	品名	仕様・規格	リース	製作	既存	引継	数量	単位	備考
1	長机				○		2	台	器具庫分使用
2	折畳椅子				○		4	脚	器具庫分使用
3									
4									
5									
6									
7									
8									
9									
10									
11									
12									
13									
14									
15									
16									
17									
18									
19									
20									
21									
22									
23									
24									
25									
26									
27									

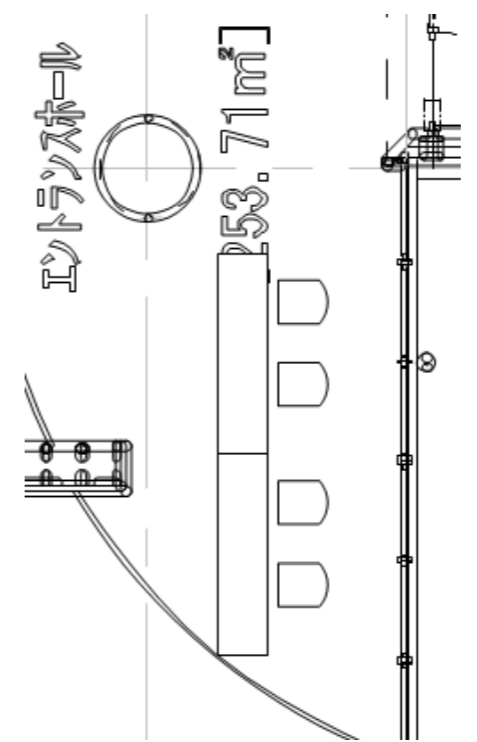

競技	番号	施設名称	設置エリア						
	13	インタビューコーナー							
No.	品名	仕様・規格	リース	製作	既存	引継	数量	単位	備考
1									
2									
3									
4									
5									
6									
7									
8									
9									
10									
11									
12									
13									
14									
15									
16									
17									
18									
19									
20									
21									
22									
23									
24									
25									
26									
27									

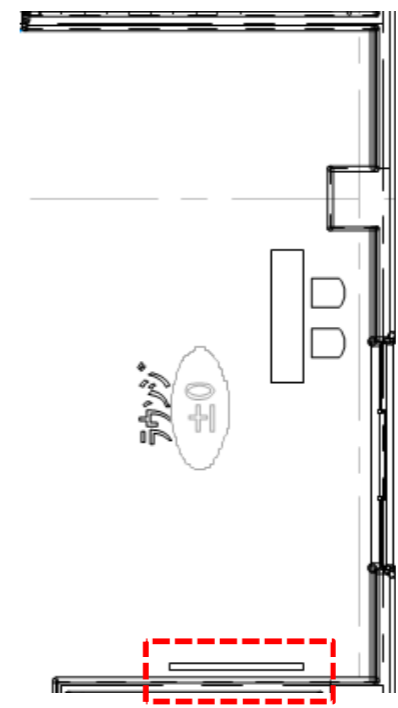

競技	番号	施設名称	設置エリア						
	14	記録速報所							
No.	品名	仕様・規格	リース	製作	既存	引継	数量	単位	備考
1	長机				○		1	台	器具庫分使用
2									
3									
4									
5									
6									
7									
8									
9									
10									
11									
12									
13									
14									
15									
16									
17									
18									
19									
20									
21									
22									
23									
24									
25									
26									
27									

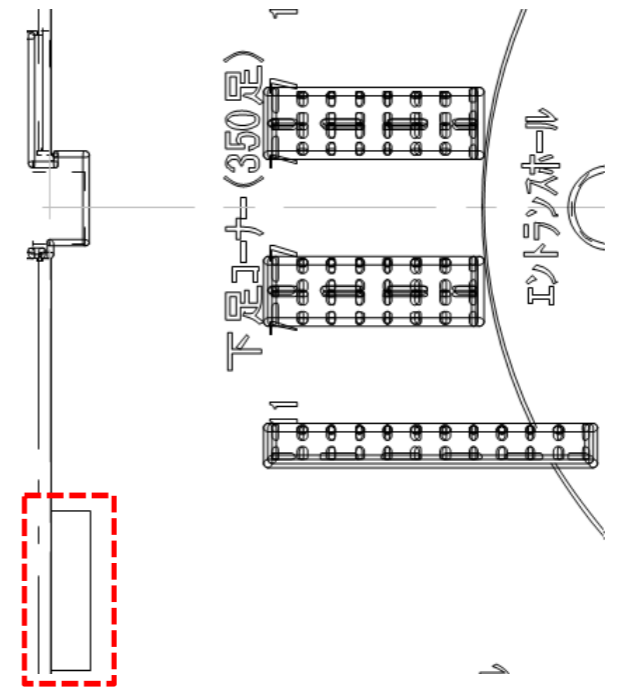

競技	番号	施設名称	設置エリア						
	15	トーナメント表							
No.	品名	仕様・規格	リース	製作	既存	引継	数量	単位	備考
1	トーナメント表			○			1	枚	看板工事にて計上
2									
3									
4									
5									
6									
7									
8									
9									
10									
11									
12									
13									
14									
15									
16									
17									
18									
19									
20									
21									
22									
23									
24									
25									
26									
27									

配置図参照

競技	番号	施設名称	設置エリア						
	16	選手・監督・関係者受付							
No.	品名	仕様・規格	リース	製作	既存	引継	数量	単位	備考
1	長机				○		2	台	器具庫分使用
2	折畳椅子				○		4	脚	器具庫分使用
3									
4									
5									
6									
7									
8									
9									
10									
11									
12									
13									
14									
15									
16									
17									
18									
19									
20									
21									
22									
23									
24									
25									
26									
27									

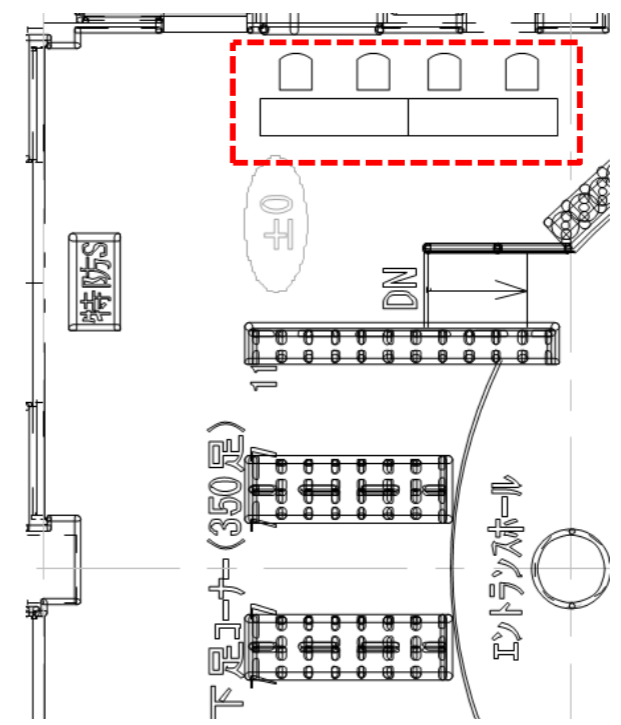

競技	番号	施設名称	設置エリア						
	17	テクニカルオフィシャル控室							
No.	品名	仕様・規格	リース	製作	既存	引継	数量	単位	備考
1	長机		○				6	台	
2	折畳椅子				○		18	脚	器具庫分使用
3									
4									
5									
6									
7									
8									
9									
10									
11									
12									
13									
14									
15									
16									
17									
18									
19									
20									
21									
22									
23									
24									
25									
26									
27									

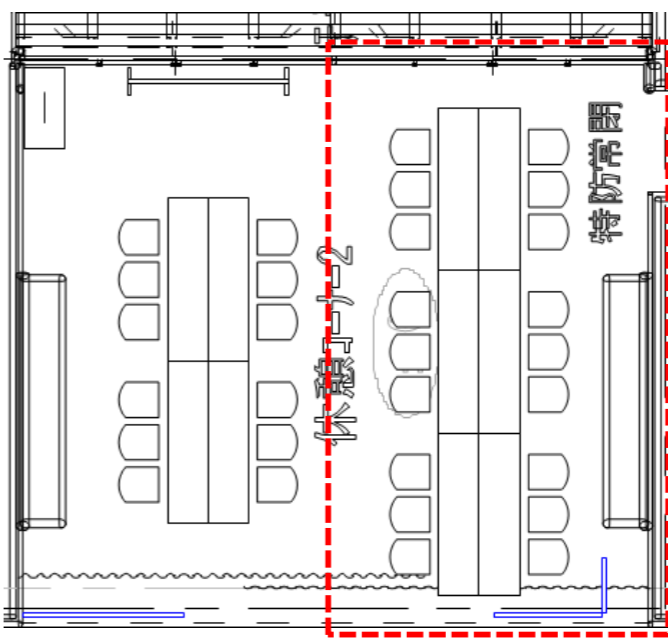

競技	番号	施設名称	設置エリア						
	18	プログラム販売所							
No.	品名	仕様・規格	リース	製作	既存	引継	数量	単位	備考
1	長机				○		1	台	器具庫分使用
2	折畳椅子				○		2	脚	器具庫分使用
3									
4									
5									
6									
7									
8									
9									
10									
11									
12									
13									
14									
15									
16									
17									
18									
19									
20									
21									
22									
23									
24									
25									
26									
27									

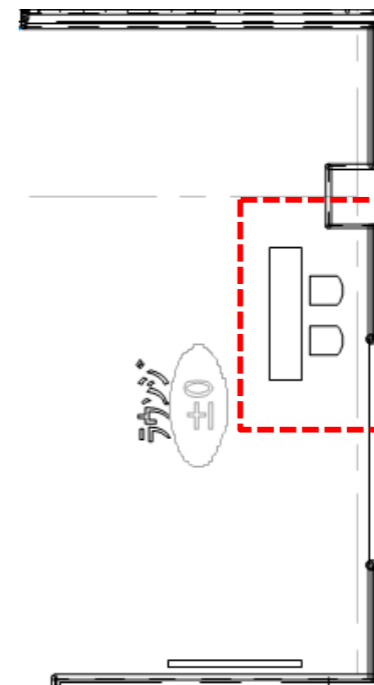

競技	番号	施設名称	設置エリア						
	19	一般観覧席							
No.	品名	仕様・規格	リース	製作	既存	引継	数量	単位	備考
1	折畳椅子		○				120	脚	
2	卓球フェンス				○		33	枚	
3									
4									
5									
6									
7									
8									
9									
10									
11									
12									
13									
14									
15									
16									
17									
18									
19									
20									
21									
22									
23									
24									
25									
26									
27									

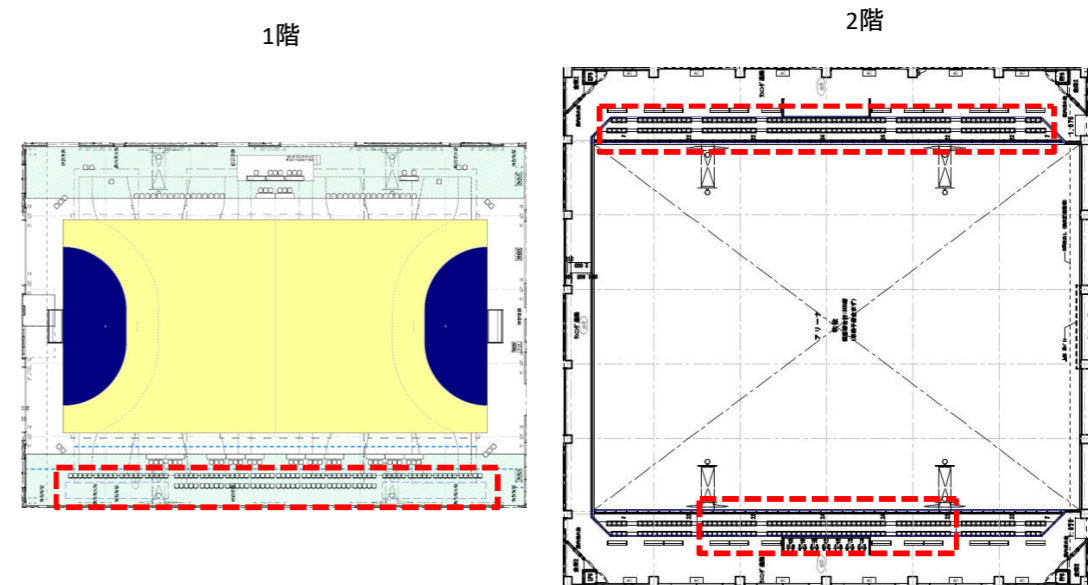

競技	番号	施設名称	設置エリア						
	20	チーム応援席							
No.	品名	仕様・規格	リース	製作	既存	引継	数量	単位	備考
1	既存利用								
2									
3									
4									
5									
6									
7									
8									
9									
10									
11									
12									
13									
14									
15									
16									
17									
18									
19									
20									
21									
22									
23									
24									
25									
26									
27									

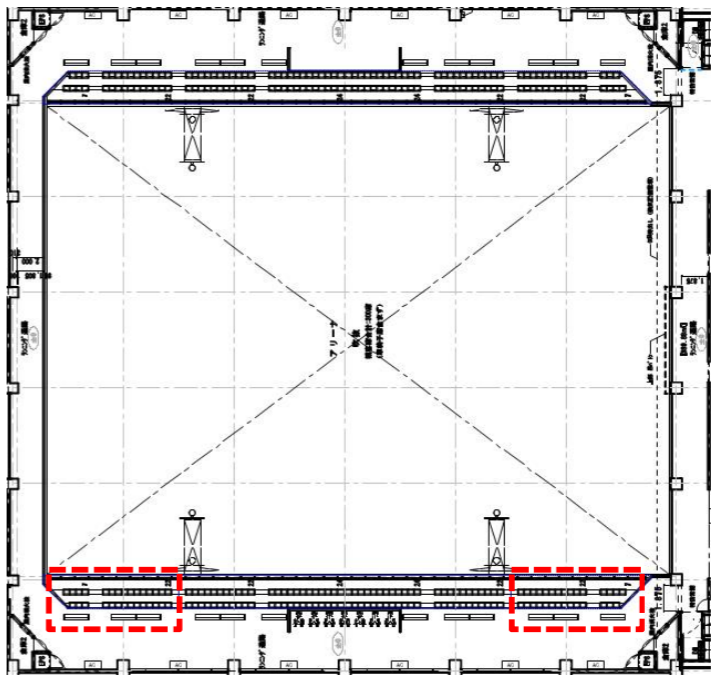

競技	番号	施設名称	設置エリア						
	21	福祉席							
No.	品名	仕様・規格	リース	製作	既存	引継	数量	単位	備考
1	折畳椅子		○				6	脚	
2									
3									
4									
5									
6									
7									
8									
9									
10									
11									
12									
13									
14									
15									
16									
17									
18									
19									
20									
21									
22									
23									
24									
25									
26									
27									

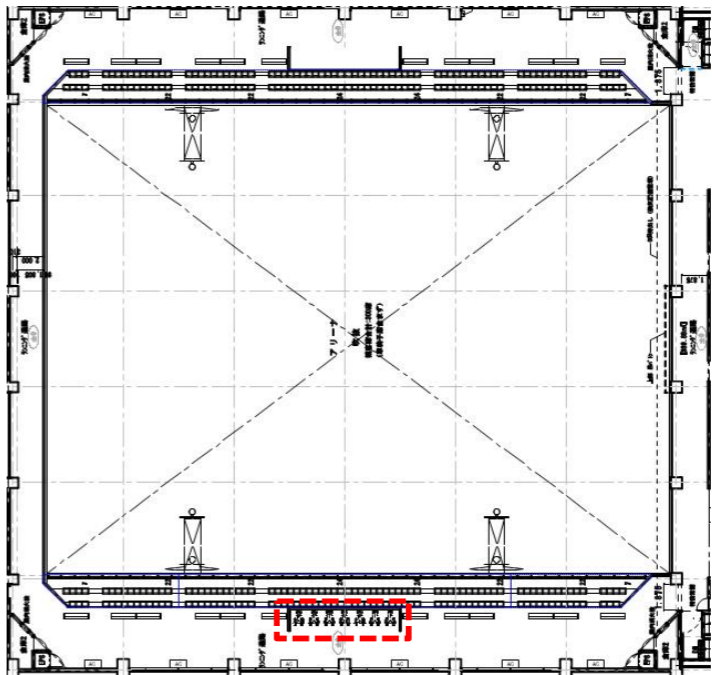

競技	番号	施設名称	設置エリア
	22	弁当引換所	
No.	品名	仕様・規格	リース 製作 既存 引継 数量 単位 備考
1	リハは設置しない		
2			
3			
4			
5			
6			
7			
8			
9			
10			
11			
12			
13			
14			
15			
16			
17			
18			
19			
20			
21			
22			
23			
24			
25			
26			
27			

競技	番号	施設名称	設置エリア
	23	選手控所	
No.	品名	仕様・規格	リース 製作 既存 引継 数量 単位 備考
1	パイプテント	2K3K	○
2	横幕	2K	○
3	横幕	3K	○
4	雨樋	2K	○
5	長机		○
6	折畳椅子		○
7	スポットクーラー		○
8			
9			
10			
11			
12			
13			
14			
15			
16			
17			
18			
19			
20			
21			
22			
23			
24			
25			
26			
27			

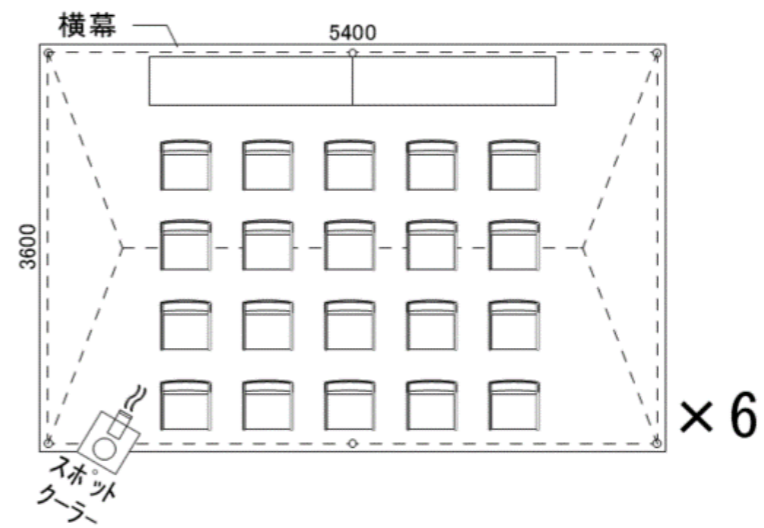

競技	番号	施設名称	設置エリア						
	24	アップ場							
No.	品名	仕様・規格	リース	製作	既存	引継	数量	単位	備考
1	卓球フェンス	W1400×H750			○		31	枚	
2									
3									
4									
5									
6									
7									
8									
9									
10									
11									
12									
13									
14									
15									
16									
17									
18									
19									
20									
21									
22									
23									
24									
25									
26									
27									

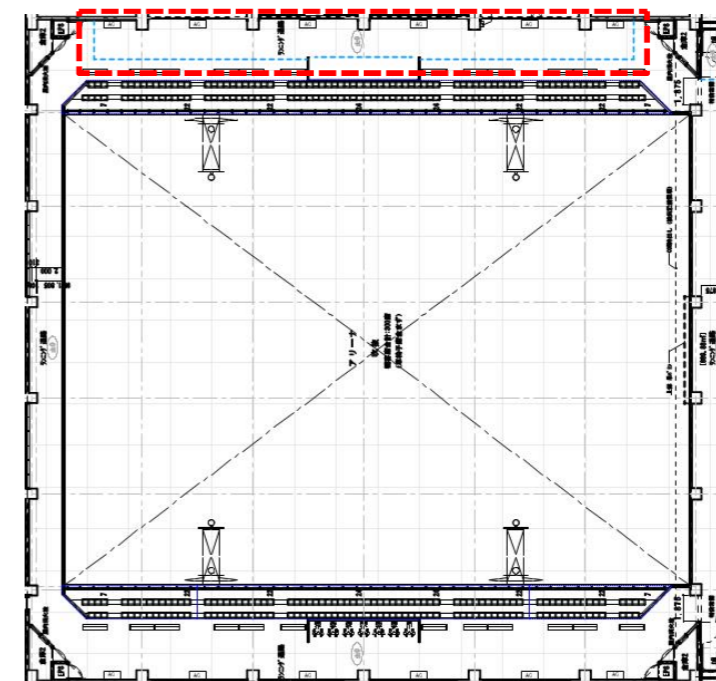

競技	番号	施設名称	設置エリア						
	25	会場案内図							
No.	品名	仕様・規格	リース	製作	既存	引継	数量	単位	備考
1	会場案内図			○			1	枚	看板工事にて計上
2									
3									
4									
5									
6									
7									
8									
9									
10									
11									
12									
13									
14									
15									
16									
17									
18									
19									
20									
21									
22									
23									
24									
25									
26									
27									

配置図参照

競技		番号	施設名称					設置エリア		
		26	ふるまいコーナー							
No.	品名	仕様・規格	リース	製作	既存	引継	数量	単位	備考	
1	リハは設置しない									
2										
3										
4										
5										
6										
7										
8										
9										
10										
11										
12										
13										
14										
15										
16										
17										
18										
19										
20										
21										
22										
23										
24										
25										
26										
27										
競技		番号	施設名称					設置エリア		
		27	売店							
No.	品名	仕様・規格	リース	製作	既存	引継	数量	単位	備考	
1	リハは設置しない									
2										
3										
4										
5										
6										
7										
8										
9										
10										
11										
12										
13										
14										
15										
16										
17										
18										
19										
20										
21										
22										
23										
24										
25										
26										
27										

競技		番号	施設名称				設置エリア			
		28	一般休憩所							
No.	品名	仕様・規格		リース	製作	既存	引継	数量	単位	備考
1	リハは設置しない									
2										
3										
4										
5										
6										
7										
8										
9										
10										
11										
12										
13										
14										
15										
16										
17										
18										
19										
20										
21										
22										
23										
24										
25										
26										
27										
競技		番号	施設名称				設置エリア			
		29	無料ドリンクコーナー							
No.	品名	仕様・規格		リース	製作	既存	引継	数量	単位	備考
1	リハは設置しない									
2										
3										
4										
5										
6										
7										
8										
9										
10										
11										
12										
13										
14										
15										
16										
17										
18										
19										
20										
21										
22										
23										
24										
25										
26										
27										

競技		番号	施設名称				設置エリア			
		30	受付案内所							
No.	品名	仕様・規格		リース	製作	既存	引継	数量	単位	備考
1	リハは設置しない									
2										
3										
4										
5										
6										
7										
8										
9										
10										
11										
12										
13										
14										
15										
16										
17										
18										
19										
20										
21										
22										
23										
24										
25										
26										
27										

競技		番号	施設名称				設置エリア			
		31	バス乗降所							
No.	品名	仕様・規格		リース	製作	既存	引継	数量	単位	備考
1	34と兼用									
2										
3										
4										
5										
6										
7										
8										
9										
10										
11										
12										
13										
14										
15										
16										
17										
18										
19										
20										
21										
22										
23										
24										
25										
26										
27										

競技	番号	施設名称					設置エリア			
	32	ごみ集積所								
No.	品名	仕様・規格	リース	製作	既存	引継	数量	単位	備考	
1	パイプテント	1.5K2K	○				1	張		
2	横幕	1.5K	○				2	枚		
3	横幕	2K	○				2	枚		
4	ブルーシート		○				1	枚		
5										
6										
7										
8										
9										
10										
11										
12										
13										
14										
15										
16										
17										
18										
19										
20										
21										
22										
23										
24										
25										
26										
27										

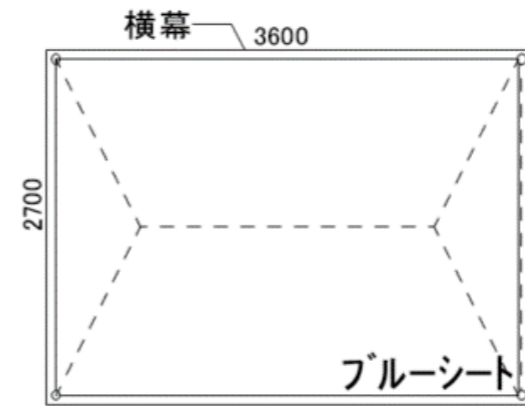

競技	番号	施設名称					設置エリア			
	33	喫煙所								
No.	品名	仕様・規格	リース	製作	既存	引継	数量	単位	備考	
1	リハは設置しない									
2										
3										
4										
5										
6										
7										
8										
9										
10										
11										
12										
13										
14										
15										
16										
17										
18										
19										
20										
21										
22										
23										
24										
25										
26										
27										

競技	番号	施設名称	設置エリア						
	34	駐車場係控所							
No.	品名	仕様・規格	リース	製作	既存	引継	数量	単位	備考
1	パイプテント	1.5K2K	○				1	張	
2	横幕	1.5K	○				2	枚	
3	横幕	2K	○				2	枚	
4	長机		○				2	卓	
5	折畳椅子		○				4	脚	
6	整理棚		○				1	台	
7	ホワイトボード		○				1	台	
8	スポットクーラー		○				1	台	
9									
10									
11									
12									
13									
14									
15									
16									
17									
18									
19									
20									
21									
22									
23									
24									
25									
26									
27									

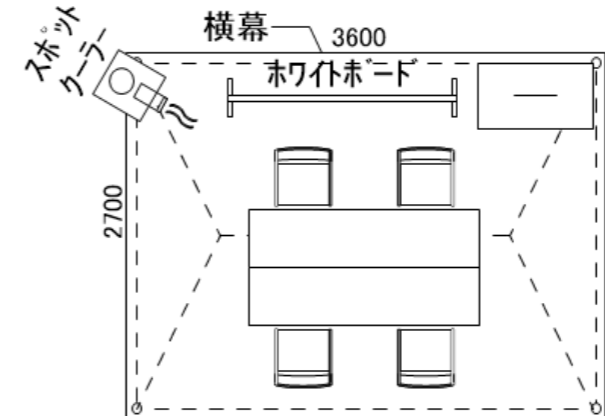

競技	番号	施設名称	設置エリア						
	35	一般駐車場							
No.	品名	仕様・規格	リース	製作	既存	引継	数量	単位	備考
1	リハ・本大会は設置予定なし(本大会は総合体育館のみ設置)								
2									
3									
4									
5									
6									
7									
8									
9									
10									
11									
12									
13									
14									
15									
16									
17									
18									
19									
20									
21									
22									
23									
24									
25									
26									
27									

競技		番号	施設名称				設置エリア			
		36	関係者駐車場							
No.	品名	仕様・規格		リース	製作	既存	引継	数量	単位	備考
1										
2										
3										
4										
5										
6										
7										
8										
9										
10										
11										
12										
13										
14										
15										
16										
17										
18										
19										
20										
21										
22										
23										
24										
25										
26										
27										
競技		番号	施設名称				設置エリア			
		37	ADチェック							
No.	品名	仕様・規格		リース	製作	既存	引継	数量	単位	備考
1	折畳椅子					○		2	脚	器具庫分使用
2	卓球フェンス					○		1	枚	
3										
4										
5										
6										
7										
8										
9										
10										
11										
12										
13										
14										
15										
16										
17										
18										
19										
20										
21										
22										
23										
24										
25										
26										
27										

配置図参照

配置図参照

競技	番号	施設名称					設置エリア		
	38	電気工事							
No.	品名	仕様・規格	リース	製作	既存	引継	数量	単位	備考
1	【会場周辺】								
2	600Vビニル絶縁ビニルシースケーブル	VVF 2.0mm-3C	○				129	m	
3	600Vビニル絶縁ビニルシースケーブル	VVF 2.6mm-3C	○				70	m	
4	600Vビニル絶縁キャブタイプケーブル	VCT 14sq-4C	○				25	m	
5	電灯分電盤	L-G1-3	○				1	面	
6	コンセント	2P15AEx2	○				7	個	
7									
8	【競技会場内】								
9	600Vビニル絶縁電線	IV 5.5sq	○				332	m	
10	600Vビニル絶縁電線	IV 14sq	○				145	m	
11	600Vビニル絶縁ビニルシースケーブル	VVF 1.6mm-3C	○				13	m	
12	600Vビニル絶縁ビニルシースケーブル	VVF 2.0mm-3C	○				422	m	
13	600V架橋ポリエチレン絶縁ビニルシースケーブル	CV 14sq-4C	○				327	m	
14	トリプルレックス形架橋ポリエチレンケーブル	600V CVT 22sq	○				168	m	
15	トリプルレックス形架橋ポリエチレンケーブル	600V CVT 60sq	○				148	m	
16	トリプルレックス形架橋ポリエチレンケーブル	600V CVT 150sq	○				162	m	
17	電灯分電盤	LG1-1	○				1	面	
18	電灯分電盤	LG1-2	○				1	面	
19	動力盤	MG2-1	○				1	面	
20	動力盤	MG3-1	○				1	面	
21	コンセント	2P15AEx2	○				20	個	
22	発電機	G1 60KVA	○				1	台	
23	発電機	G2 150KVA	○				1	台	
24	発電機	G3 150KVA	○				1	台	
25	窓枠木板	1カ所	○				1	式	
26	接地材料	ED	○				3	式	
27	消火器(ABC粉末10型)	3台共	○				3	本	
28	ケーブル保護材	7m	○				1	式	
29	消防手続及書類作成費		○				1	式	
30	吸音パネル		○				1	式	
31									
32									
33									

競技		番号	施設名称				設置エリア			
		39	音響工事							
No.	品名	仕様・規格		リース	製作	既存	引継	数量	単位	備考
1	既存利用									
2										
3										
4										
5										
6										
7										
8										
9										
10										
11										
12										
13										
14										
15										
16										
17										
18										
19										
20										
21										
22										
23										
24										
25										
26										
27										

競技		番号	施設名称				設置エリア			
		40	映像工事							
No.	品名	仕様・規格		リース	製作	既存	引継	数量	単位	備考
1	設置なし									
2										
3										
4										
5										
6										
7										
8										
9										
10										
11										
12										
13										
14										
15										
16										
17										
18										
19										
20										
21										
22										
23										
24										
25										
26										
27										

競技		番号	施設名称				設置エリア		
		41	看板工事						
No.	品名	仕様・規格	リース	製作	既存	引継	数量	単位	備考
1	立看板(両面)			○			1	枚	(歓迎)大会名
2	大会名看板			○			1	枚	
3	旗看板			○			4	枚	国旗/市旗/協会旗/県旗
4	会場案内図			○			1	枚	
5	トーナメント表			○			1	枚	
6	プラカード枠のみ			○			4	枚	
7	修正作業・入稿作業						1	式	
8	重り		○				2	個	実行委員会持込み看板用
9									
10									
11									
12									
13									
14									
15									
16									
17									
18									
19									
20									
21									
22									
23									
24									
25									
26									
27									

競技		番号	施設名称				設置エリア		
		42	その他						
No.	品名	仕様・規格	リース	製作	既存	引継	数量	単位	備考
1	イレクターフェンス		○				14	枚	選手控所エリア・1F
2	床養生(1F)				○		456	m	
3	床養生(1F)		○				16	m	
4	据置きエアコン		○				12	台	
5									
6									
7									
8									
9									
10									
11									
12									
13									
14									
15									
16									
17									
18									
19									
20									
21									
22									
23									
24									
25									
26									
27									